



**JANUARY 2021**

# Three Person Positioning

Maggie Walsh

Colleen Spiegelhoff



# Three-Person System

Allows the officiating team to see the game from multiple and changing angles.

Enhances officials' ability to ensure Safe and Fair competition.



Provides better opportunities for officials to see space between opponents.

# Two-Person vs. Three-Person System

Lead

**A**

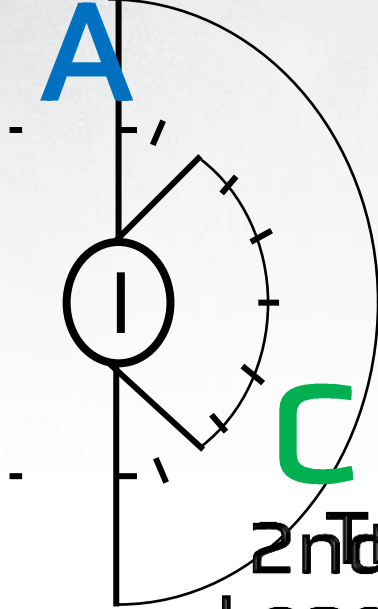

**B**

Deep Trail

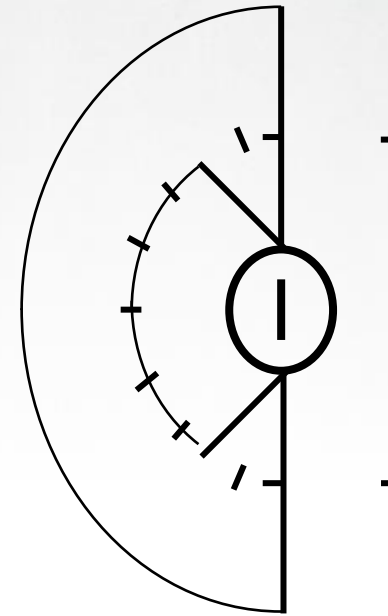
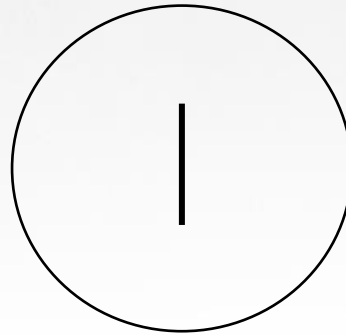



## Good Three-Person Positioning Leads To...

Better game  
management

More thorough foul  
recognition



Seeing the big picture vs. the  
small picture

# Small Picture vs. Big Picture

Empty?  
?



**Small Picture**

Empty?  
Block?



Dangerous  
check  
behind  
her?

**Big Picture**

# Three Positions

**A**

**B**

**C**

Leads to her RIGHT side		
Trails the ball going to her LEFT		
Signals the goal to her RIGHT		



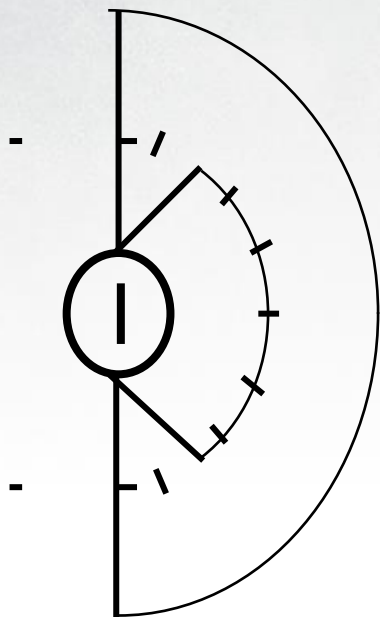

A

B

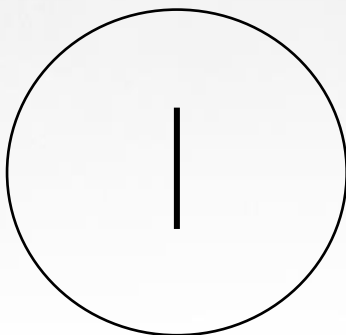

C

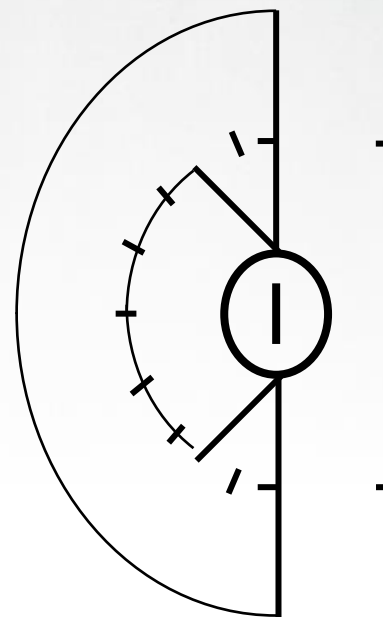

# Three Positions

**A**

**B**

**C**

Leads to her RIGHT side	Leads to her LEFT side	
Trails the ball going to her LEFT	Trails the ball going to her RIGHT	
Signals the goal to her RIGHT	Signals the goal to her LEFT	



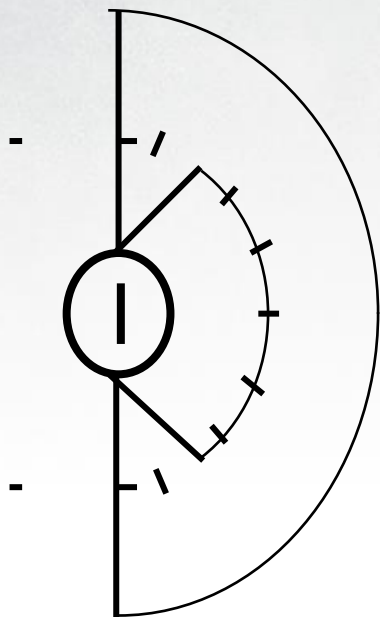

A

B

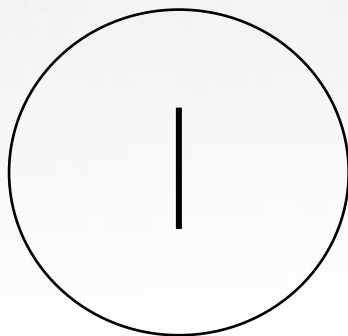

C

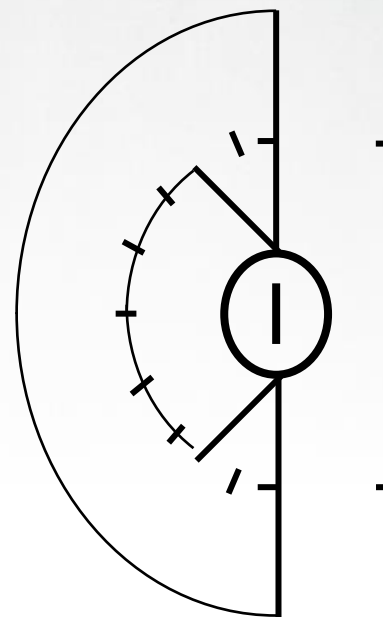

# Three Positions

## A

## B

## C

Leads to her RIGHT side	Leads to her LEFT side	Is both a Second Trail and a Second Lead
Trails the ball going to her LEFT	Trails the ball going to her RIGHT	Escorts in transition
Signals the goal to her RIGHT	Signals the goal to her LEFT	Administers all Draws

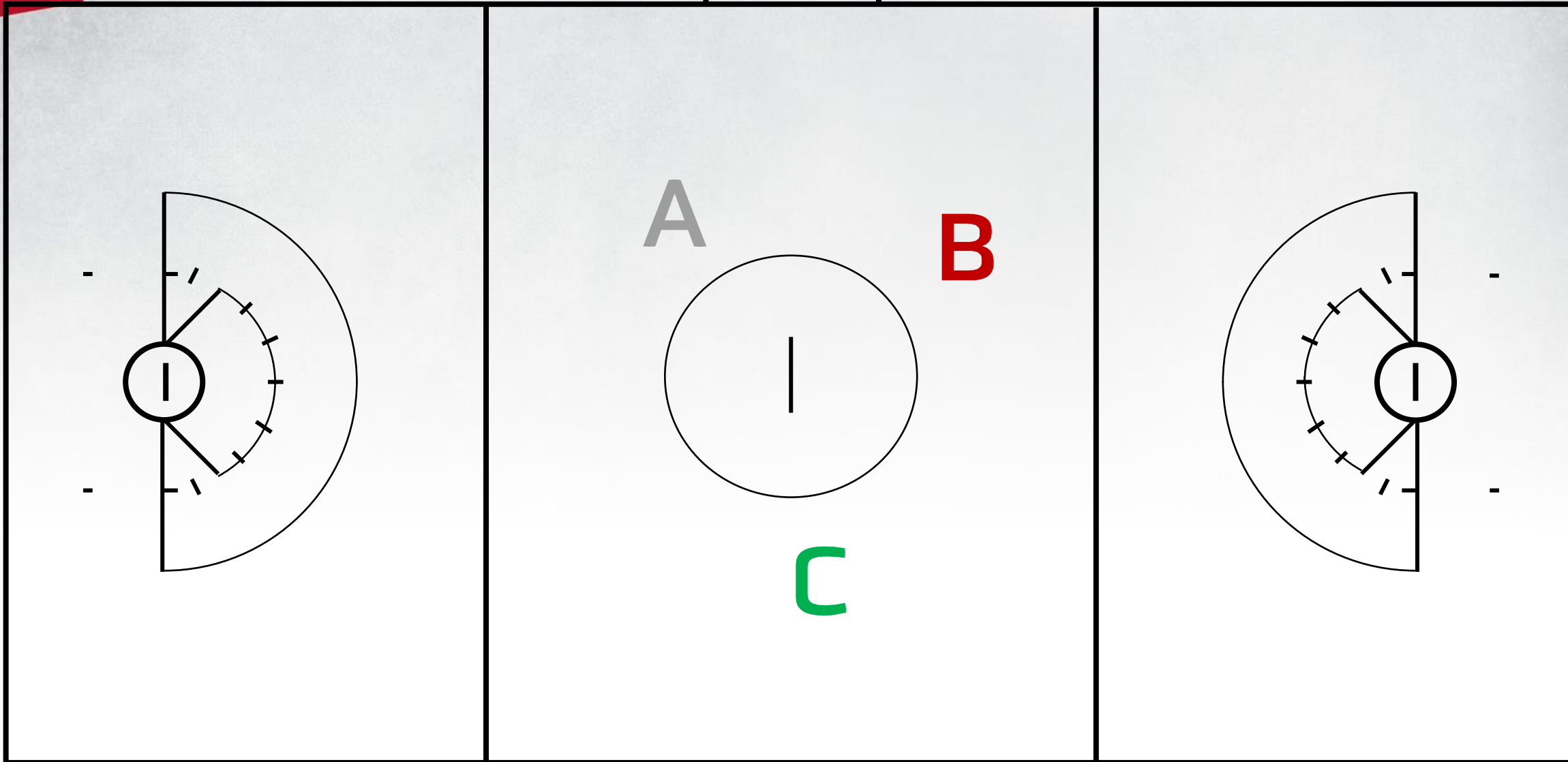



# C Positioning

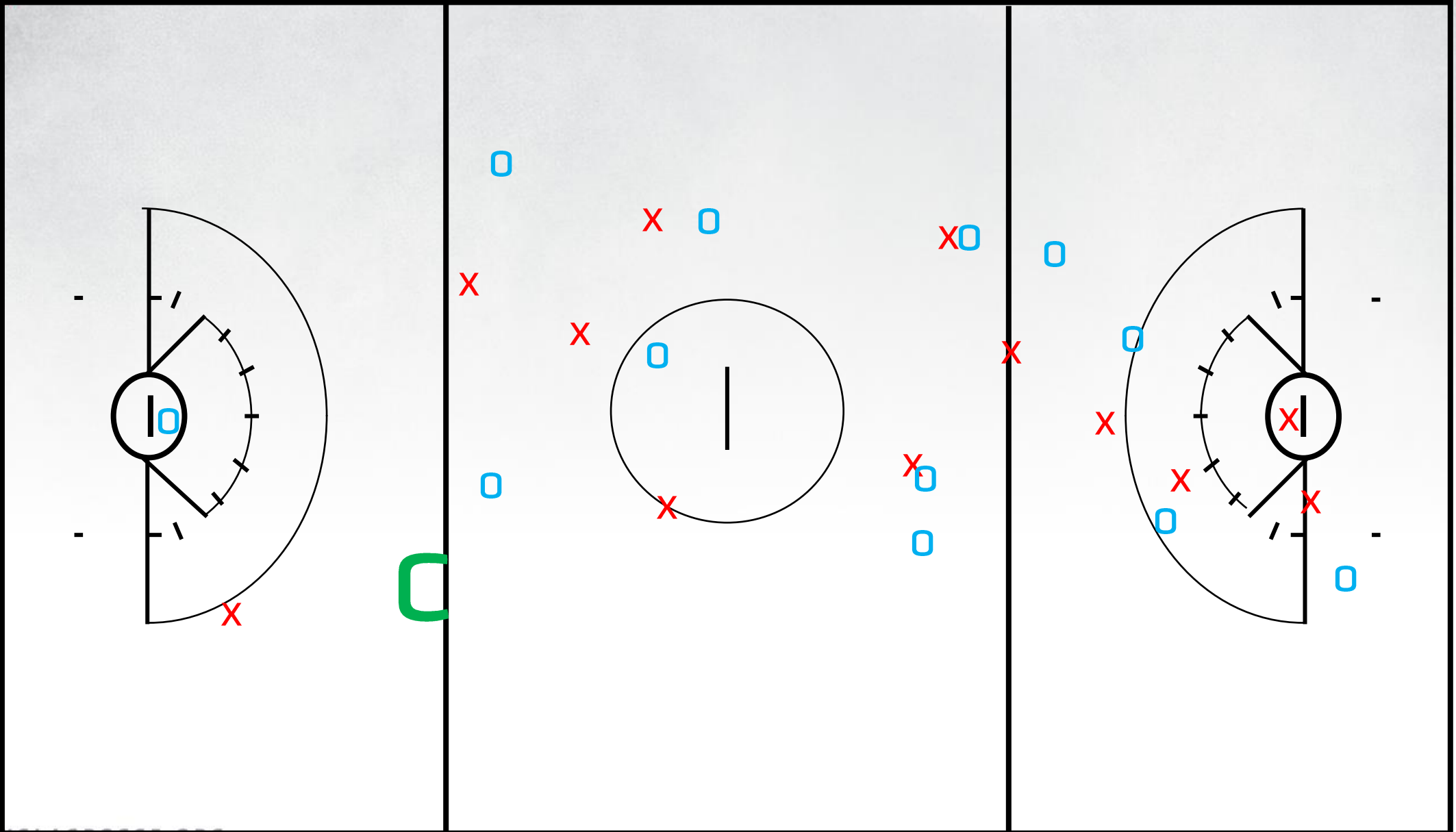

# C Positioning

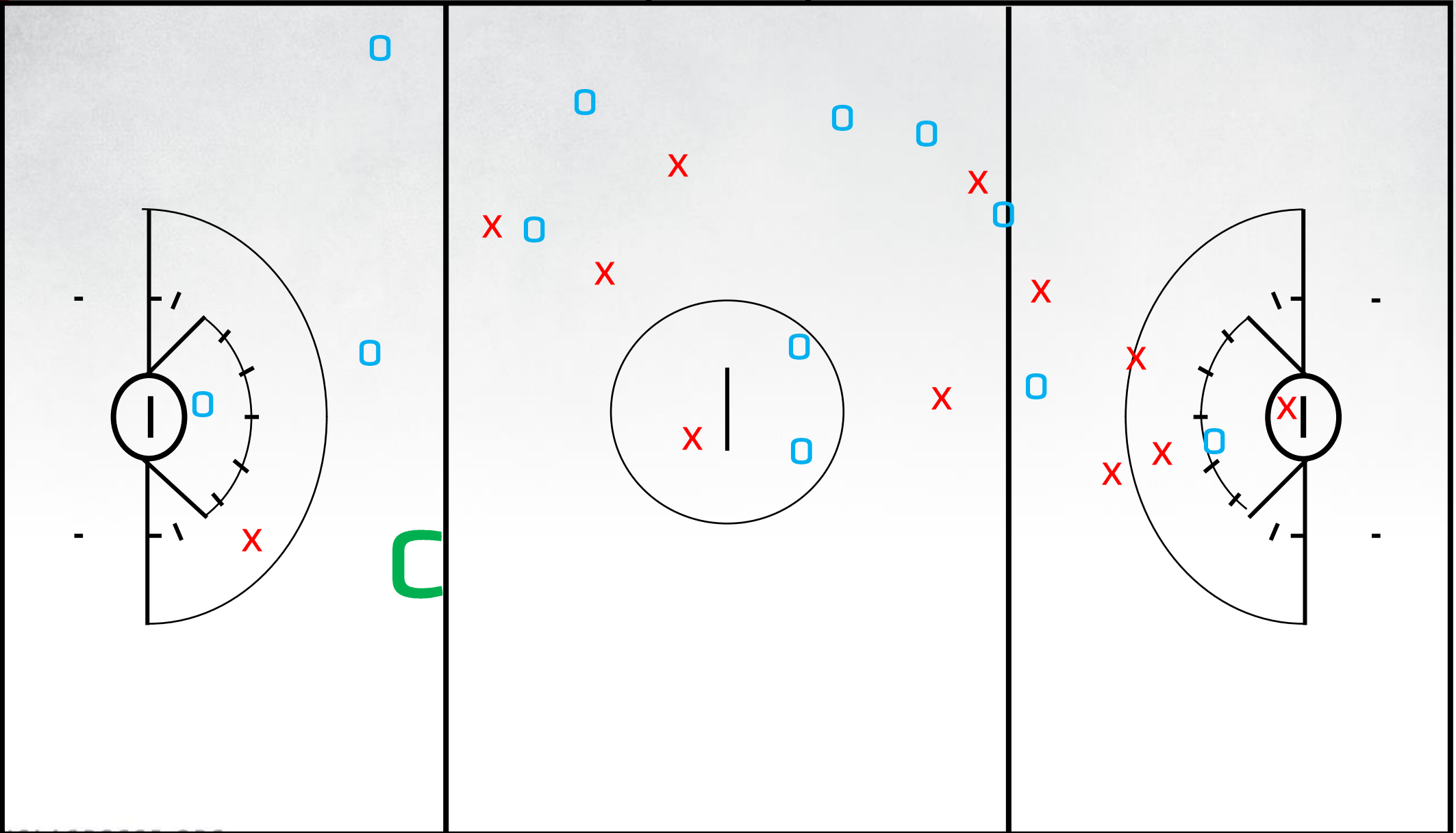

# Media Angle

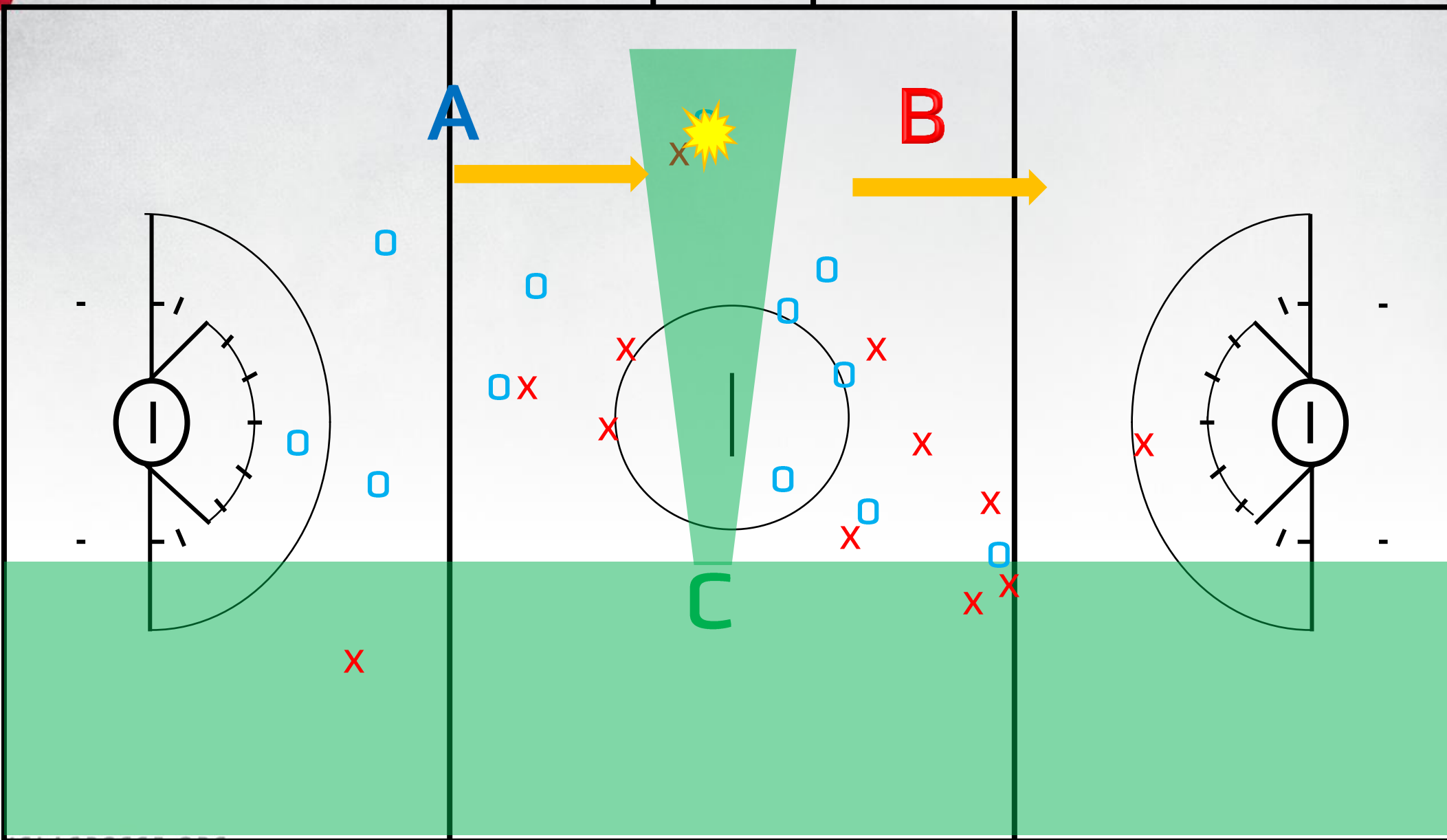



# Boundaries

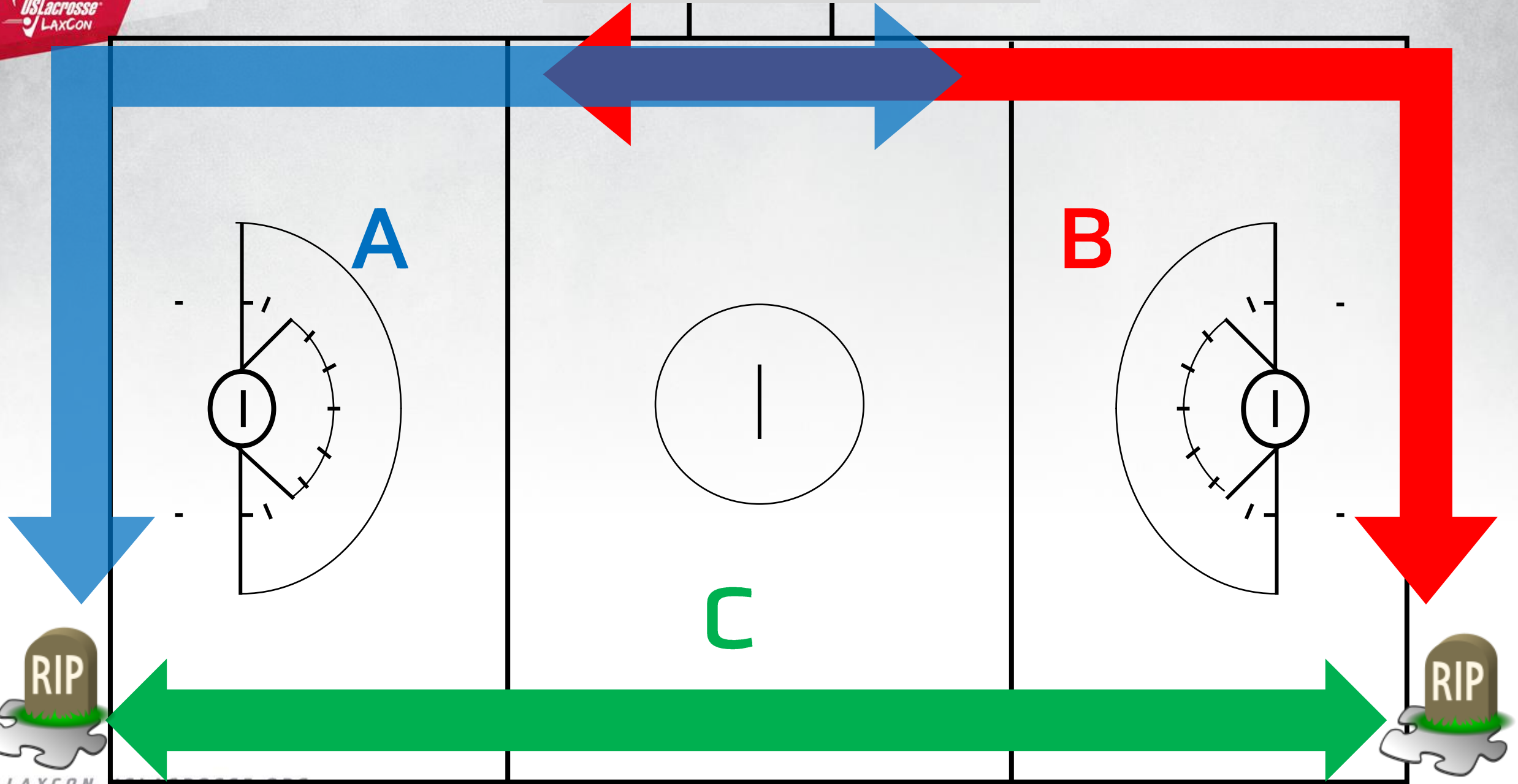

# The Draw

Watching for the same things on this side!

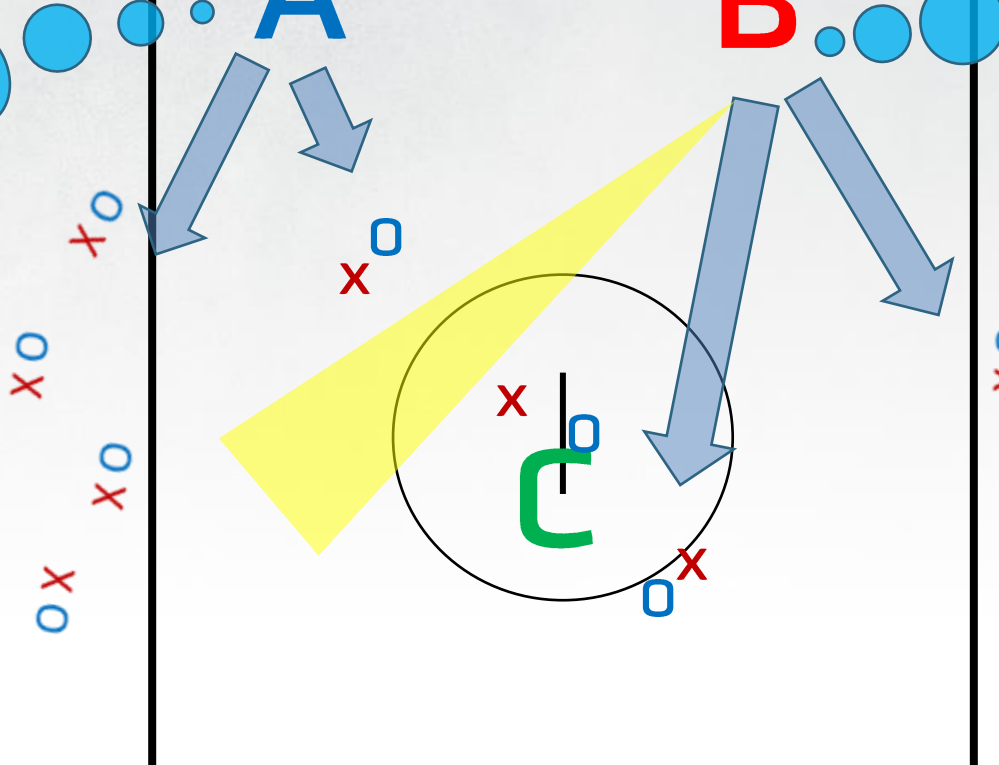
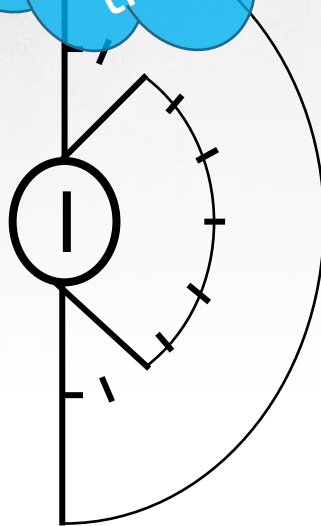

Are players on circle waiting for the whistle? Are players at RL waiting for possession?

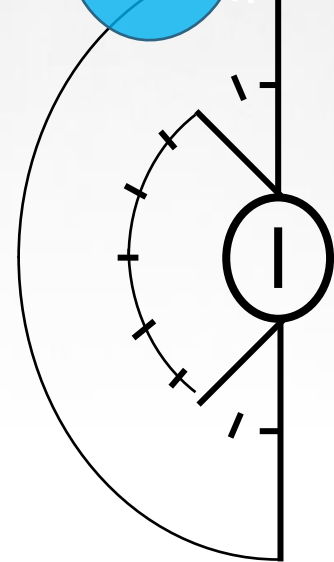

# Monitoring Play: C Official

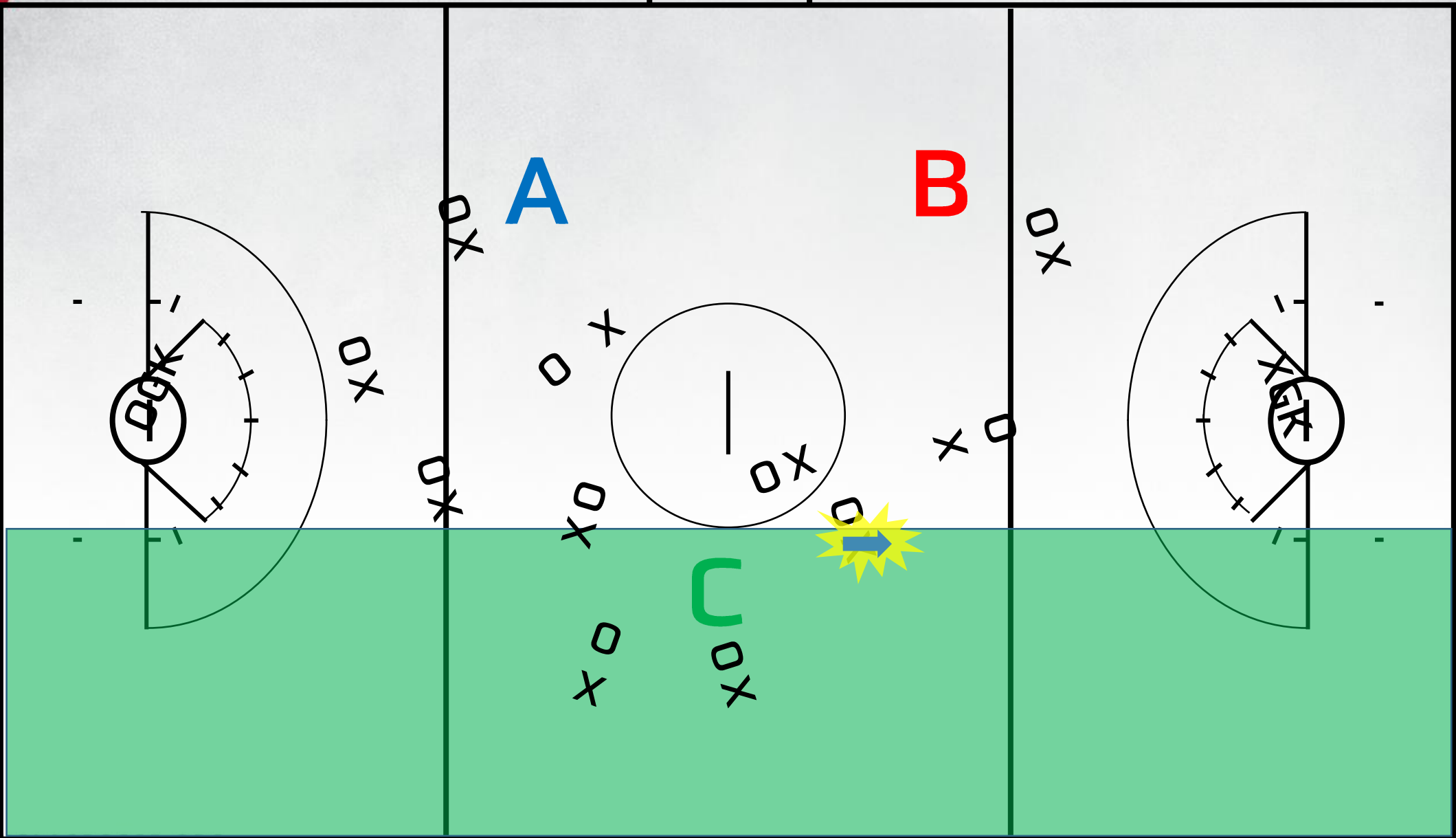



# Monitoring Play: "Release" To A

## Partner

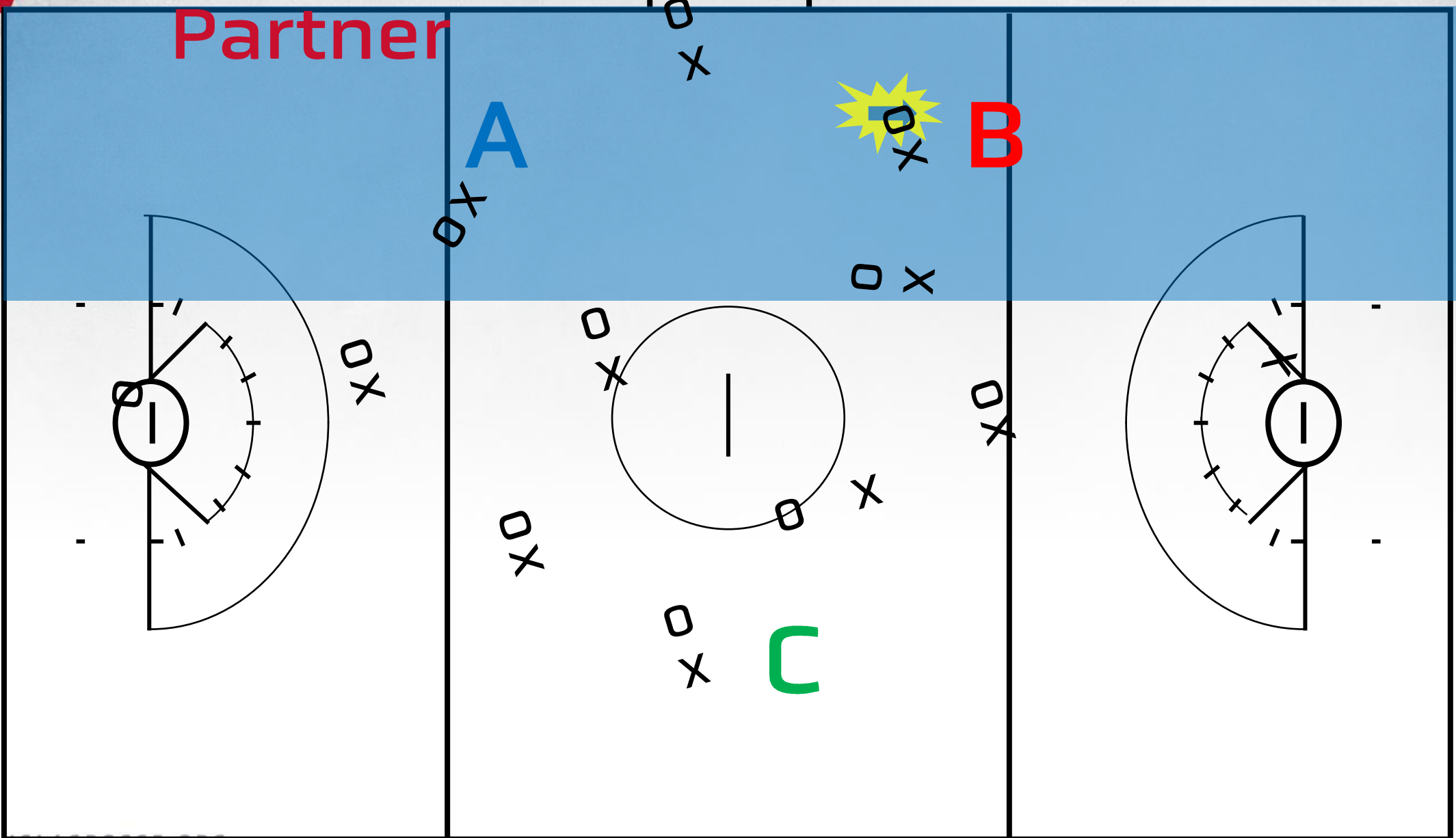

# Monitoring Play: Middle Of The Field

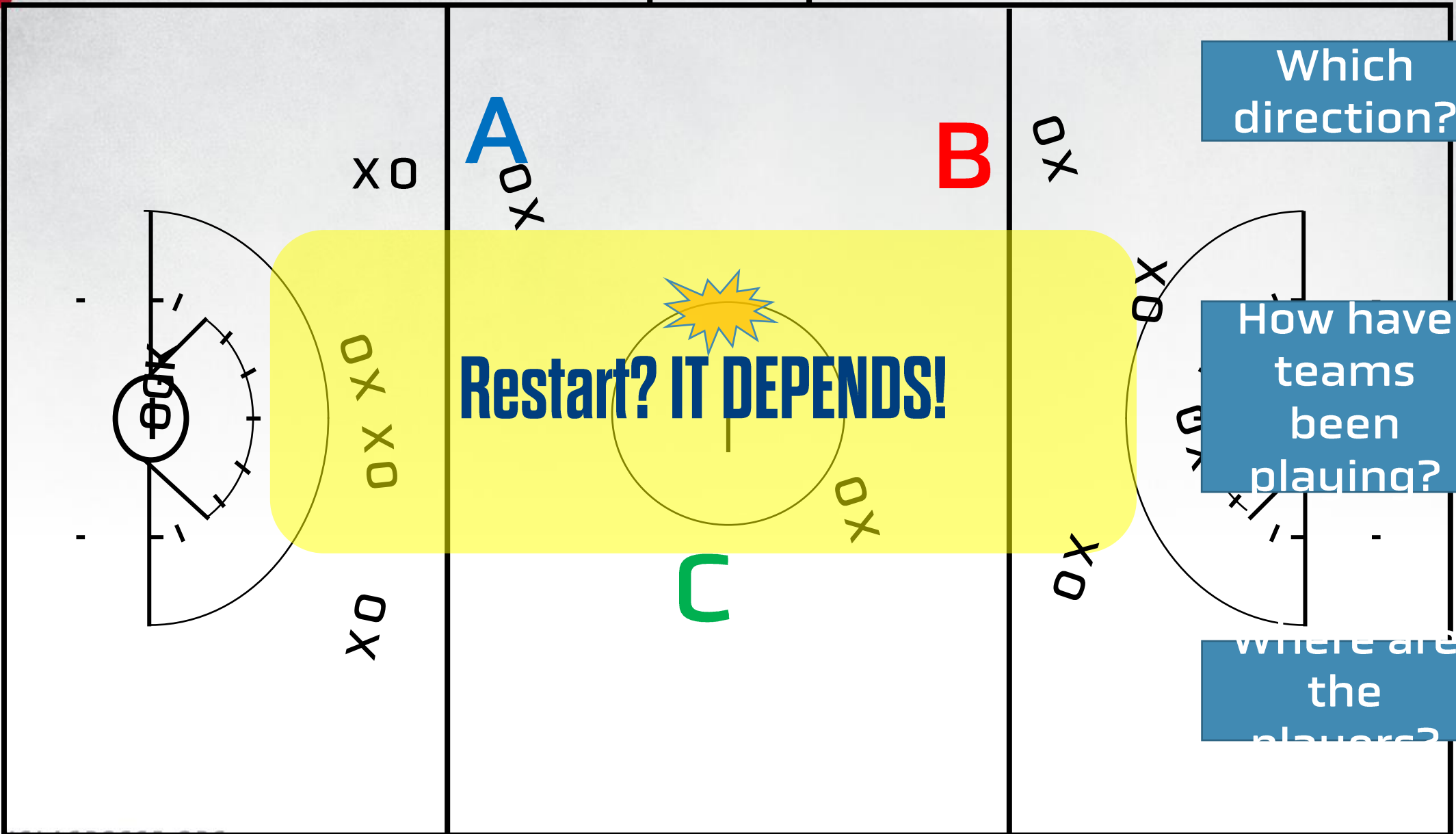

# Monitoring Play: Middle Of The Field Release

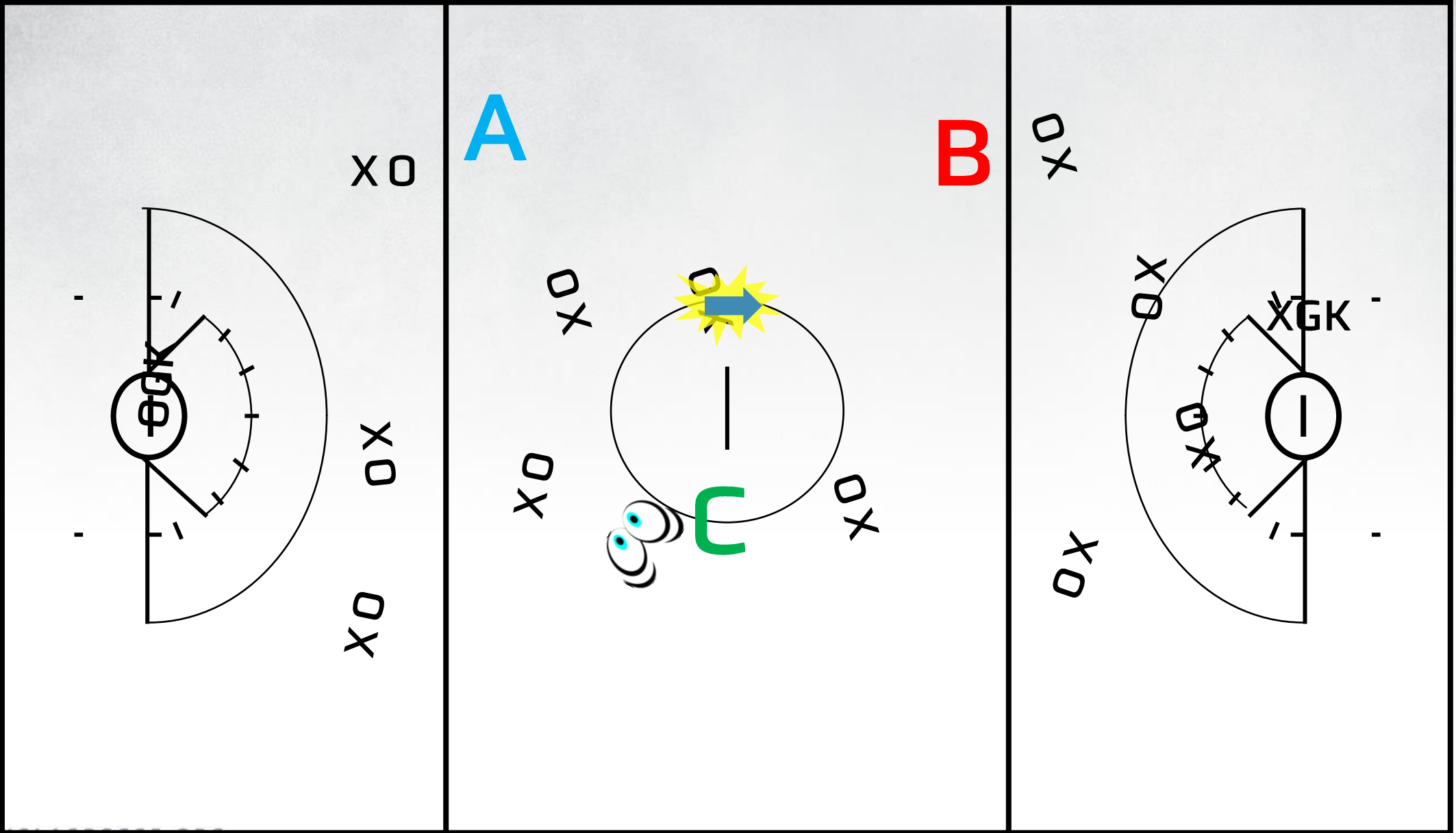

# Arcs Of Movement

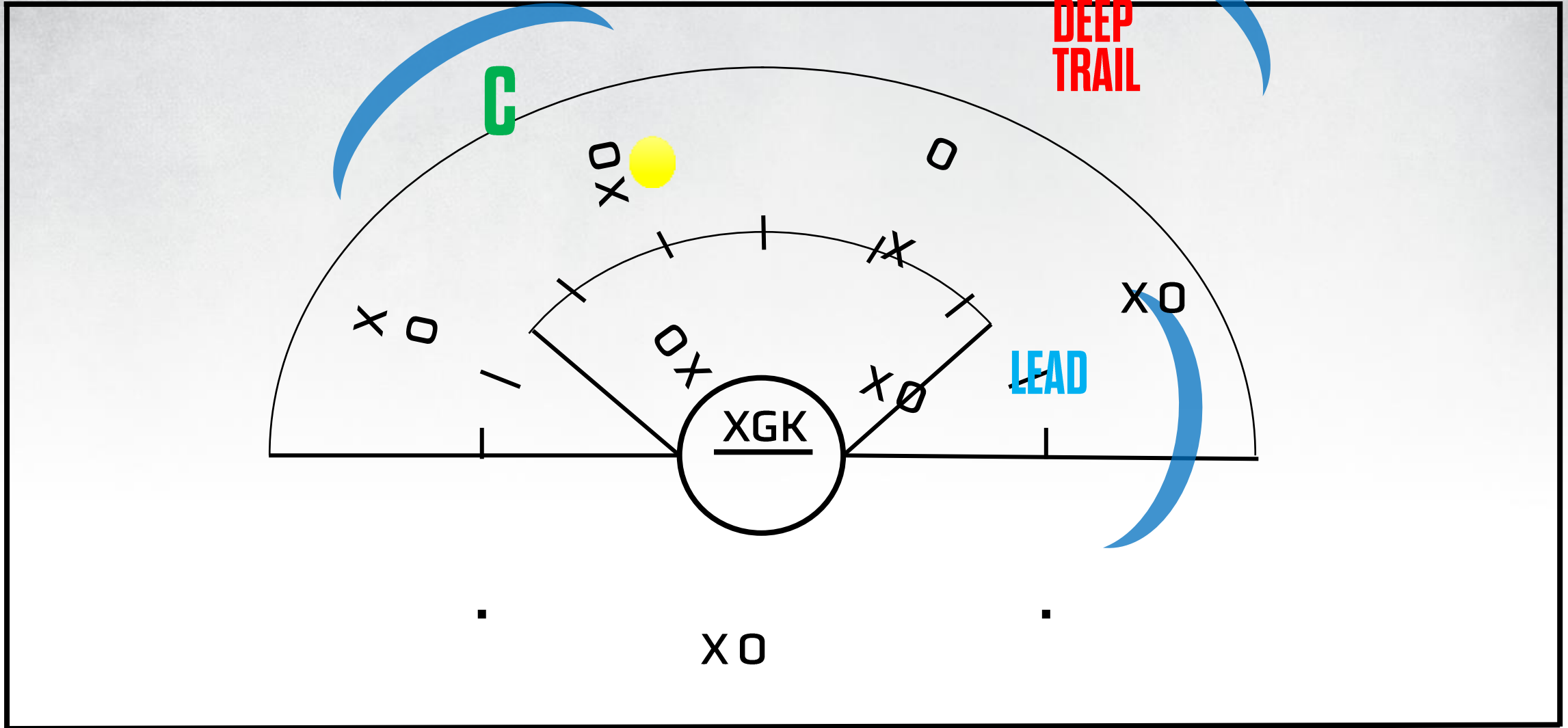



# Lead Range Of Motion

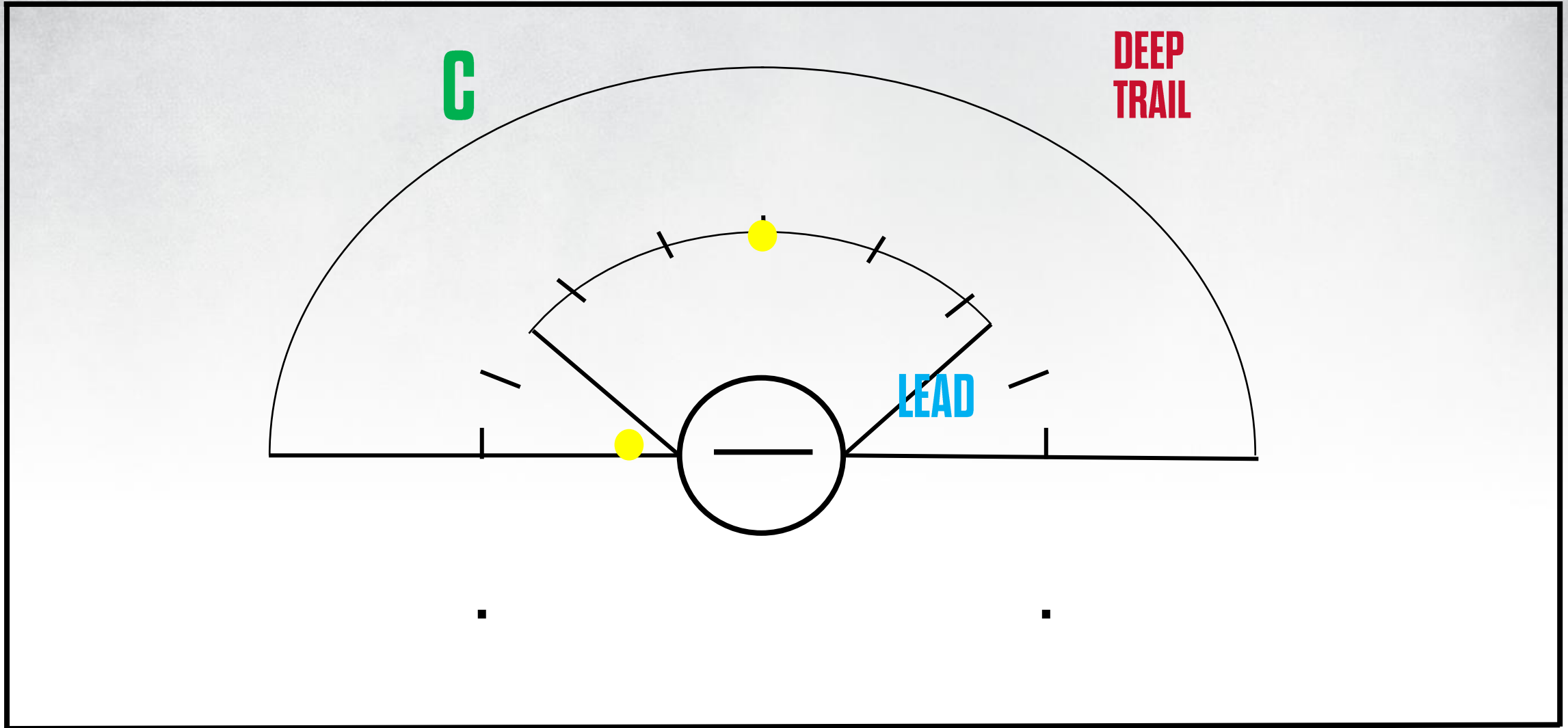

# Lead Focus

TRAIL

LEAD

C

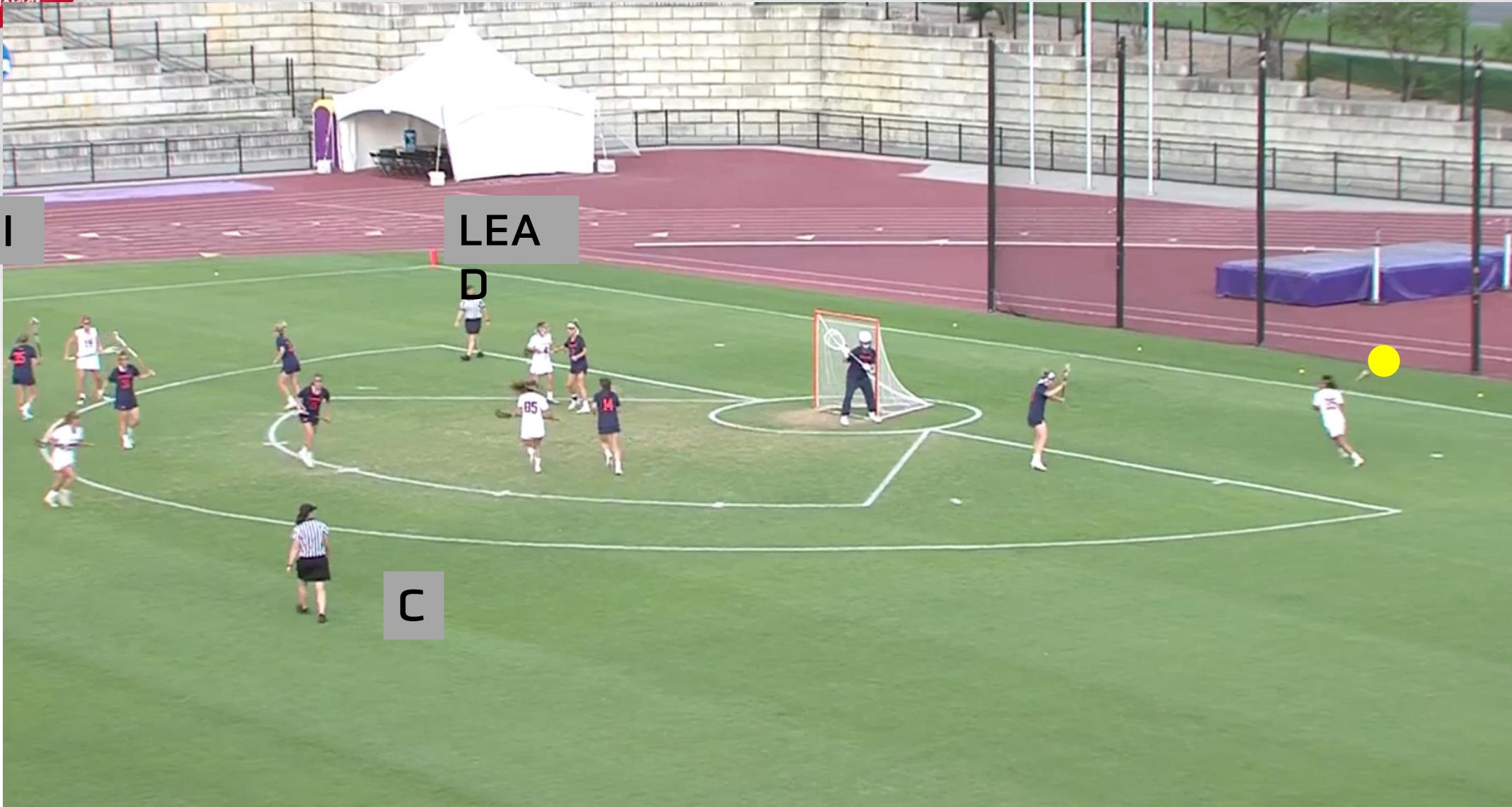

# Lead Focus

TRAIL

LEAD

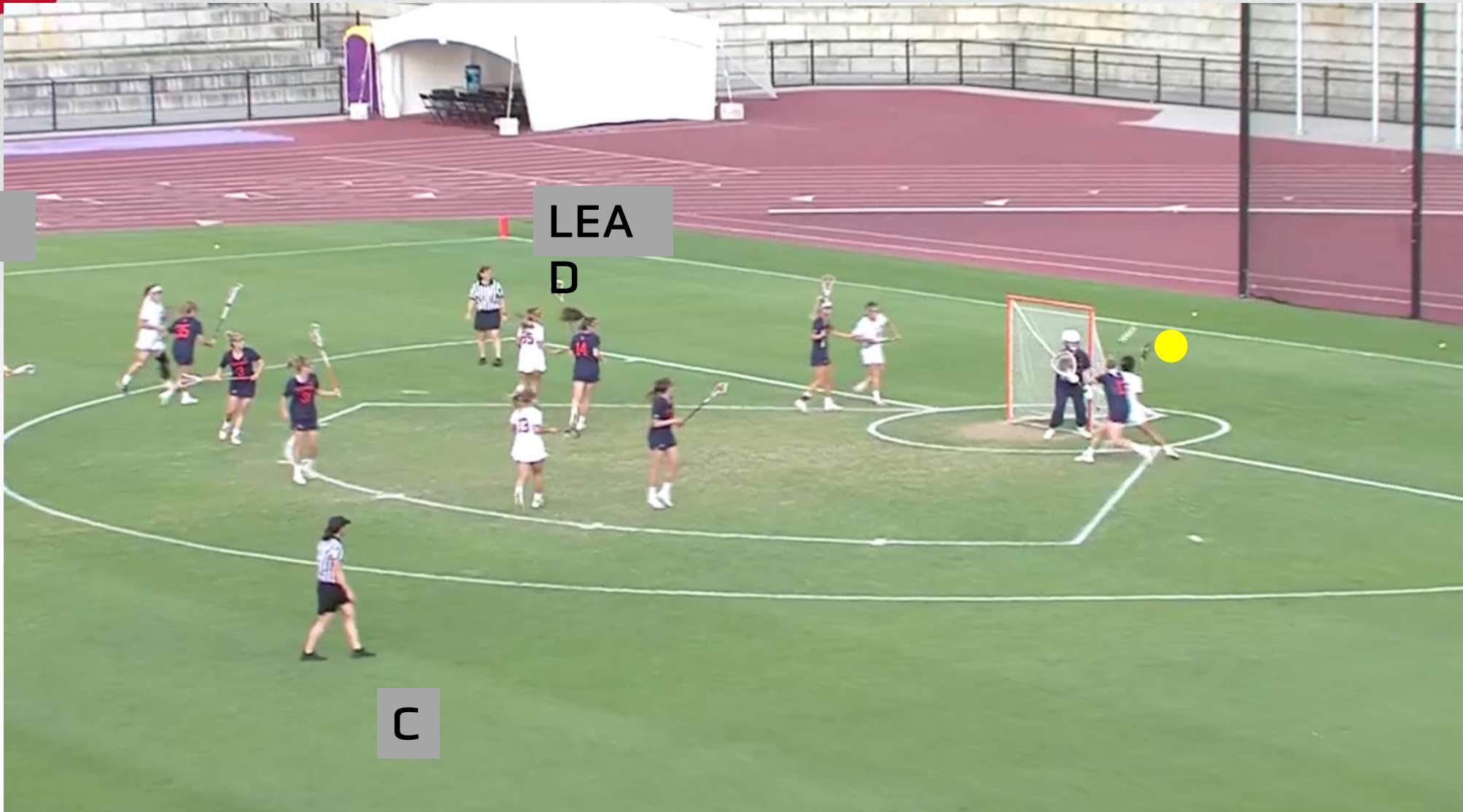

C



# Lead Focus

TRAIL

LEAD

C

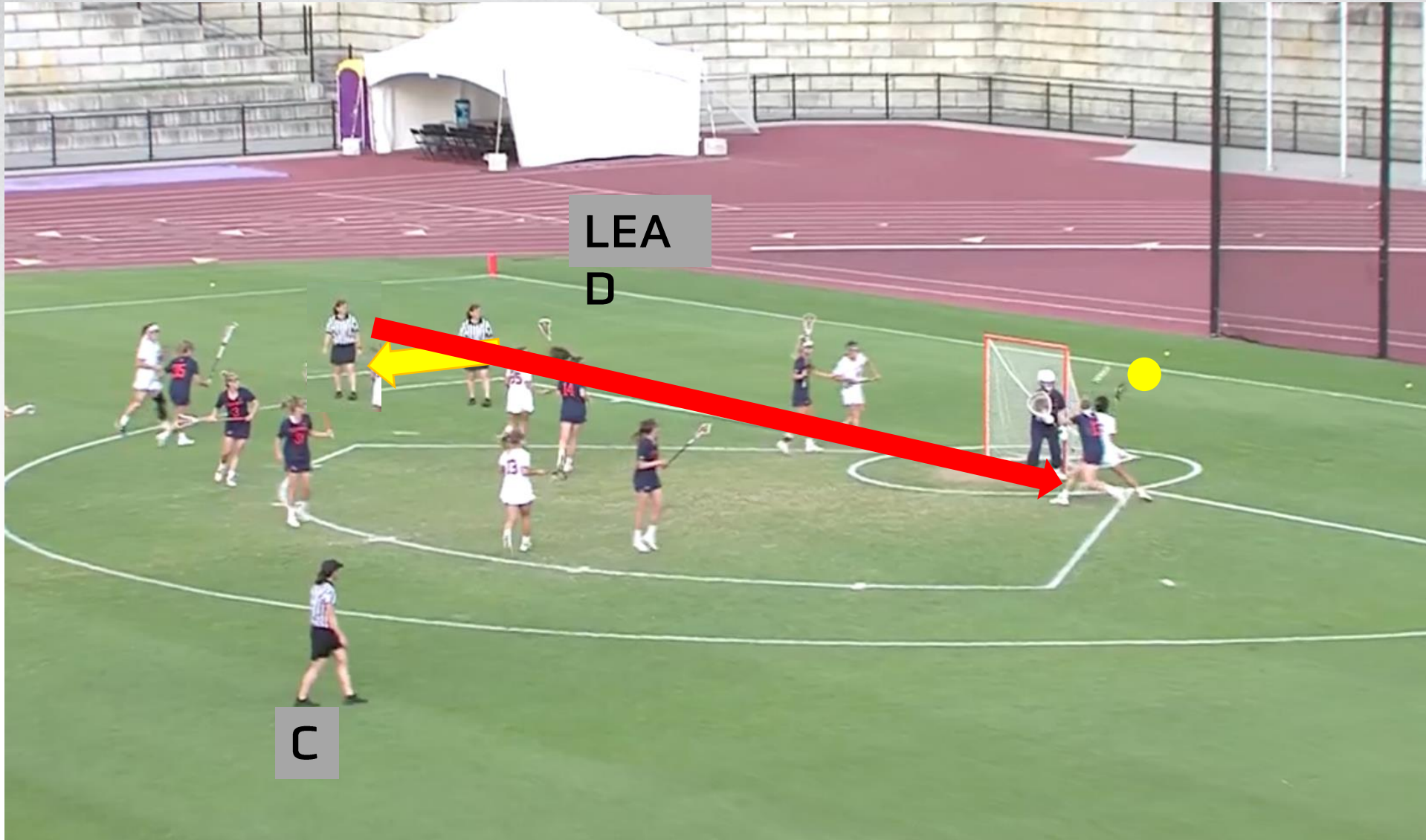



# C Range Of Motion

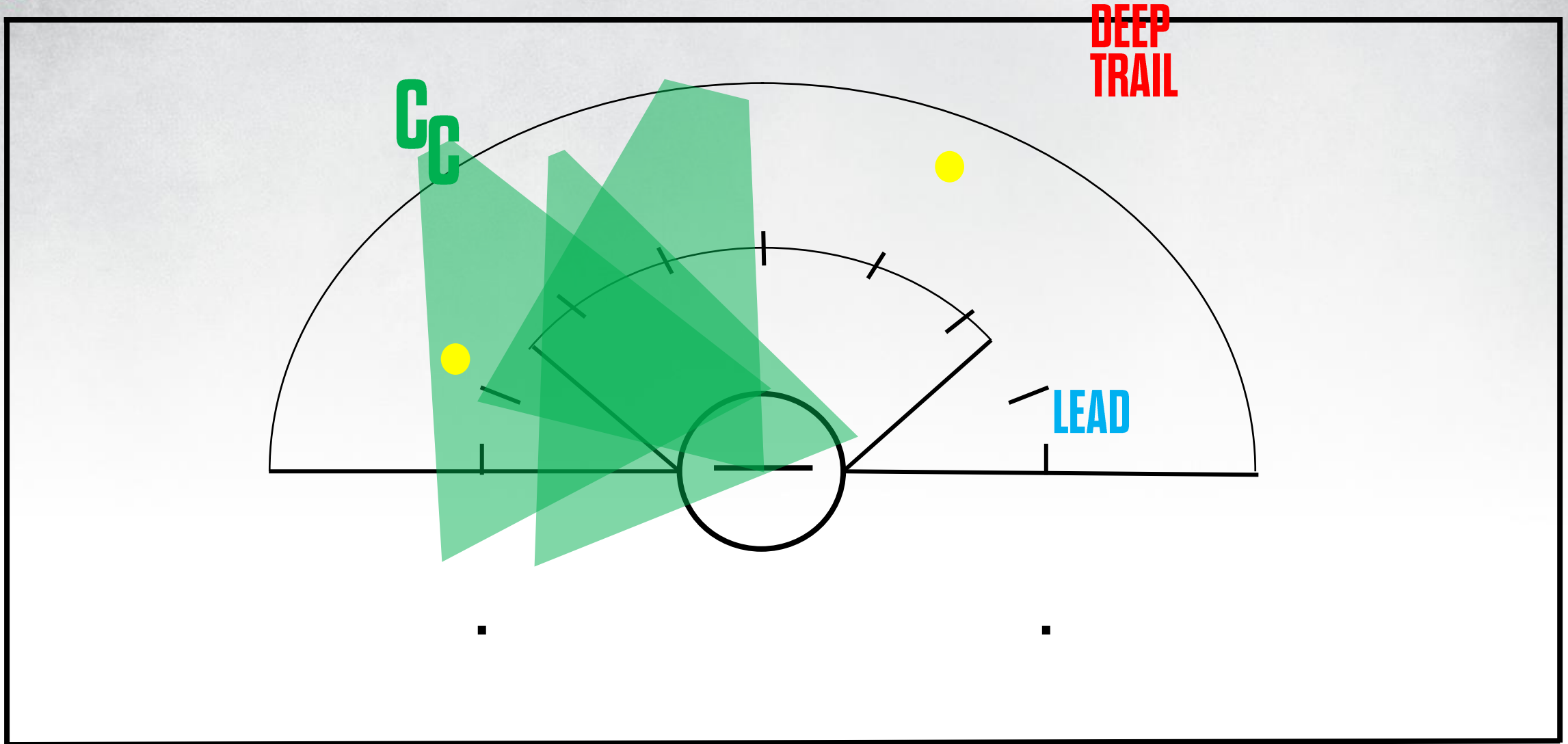

# C Focus

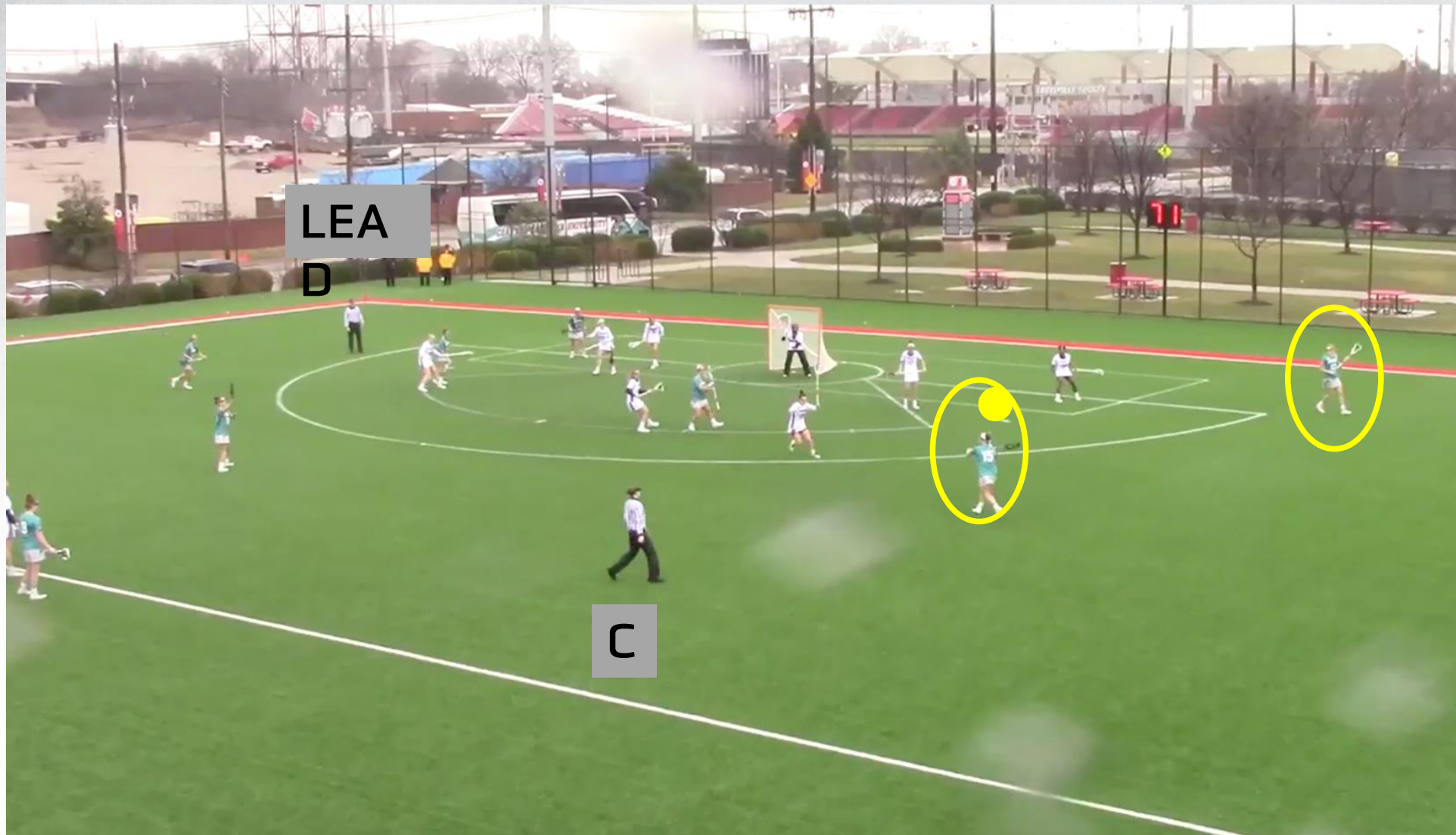

LEAD  
D

TRAIL

C

# C Focus



TRAIL

LEAD  
D

C



# C Focus



TRAIL



# C Focus

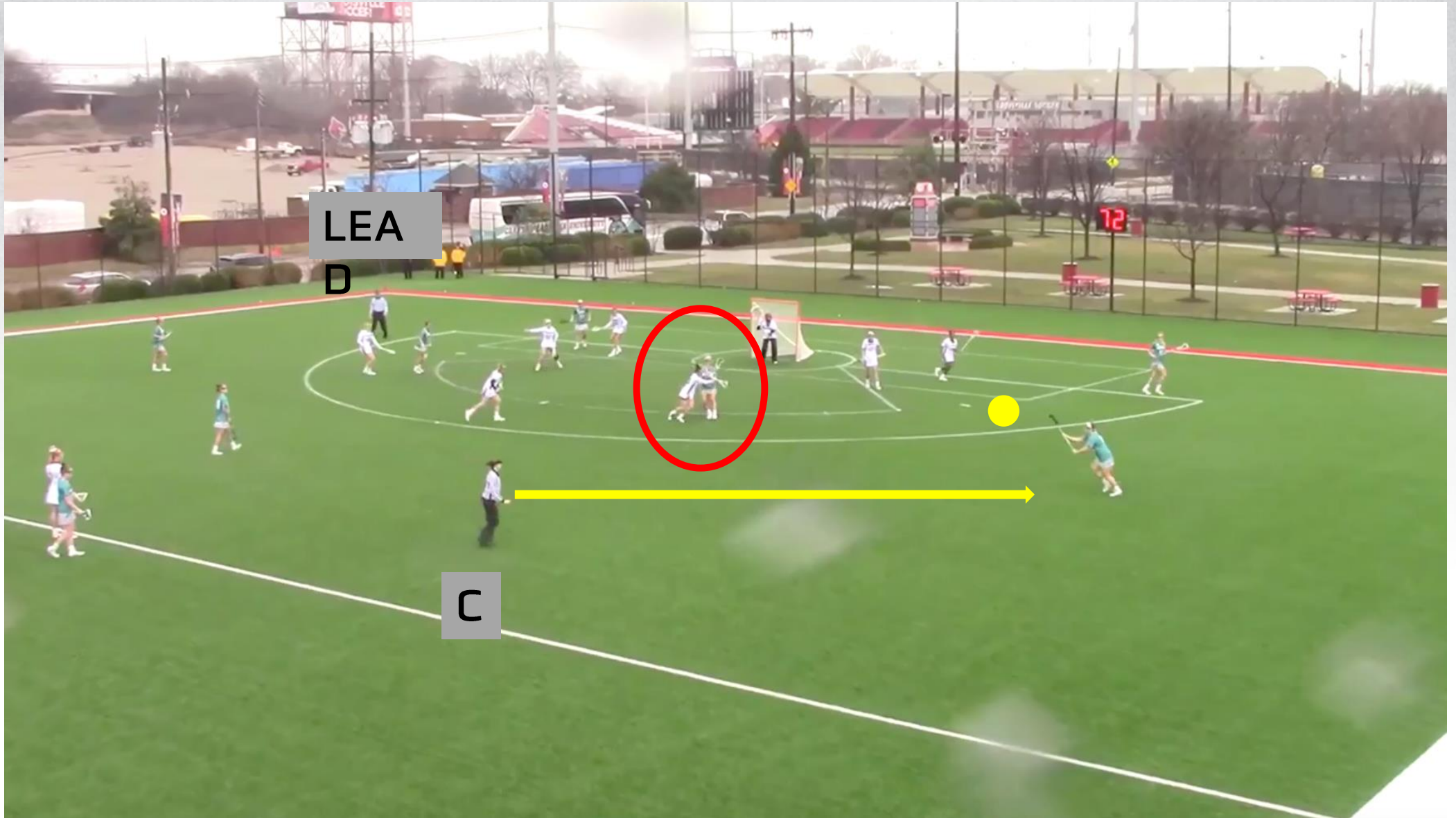

LEA  
D

TRAIL

C

# C Focus

LEA  
D

TRAIL

C

Focus on area where the potential for unsafe or unfair play may happen

# Deep Trail Range Of Motion

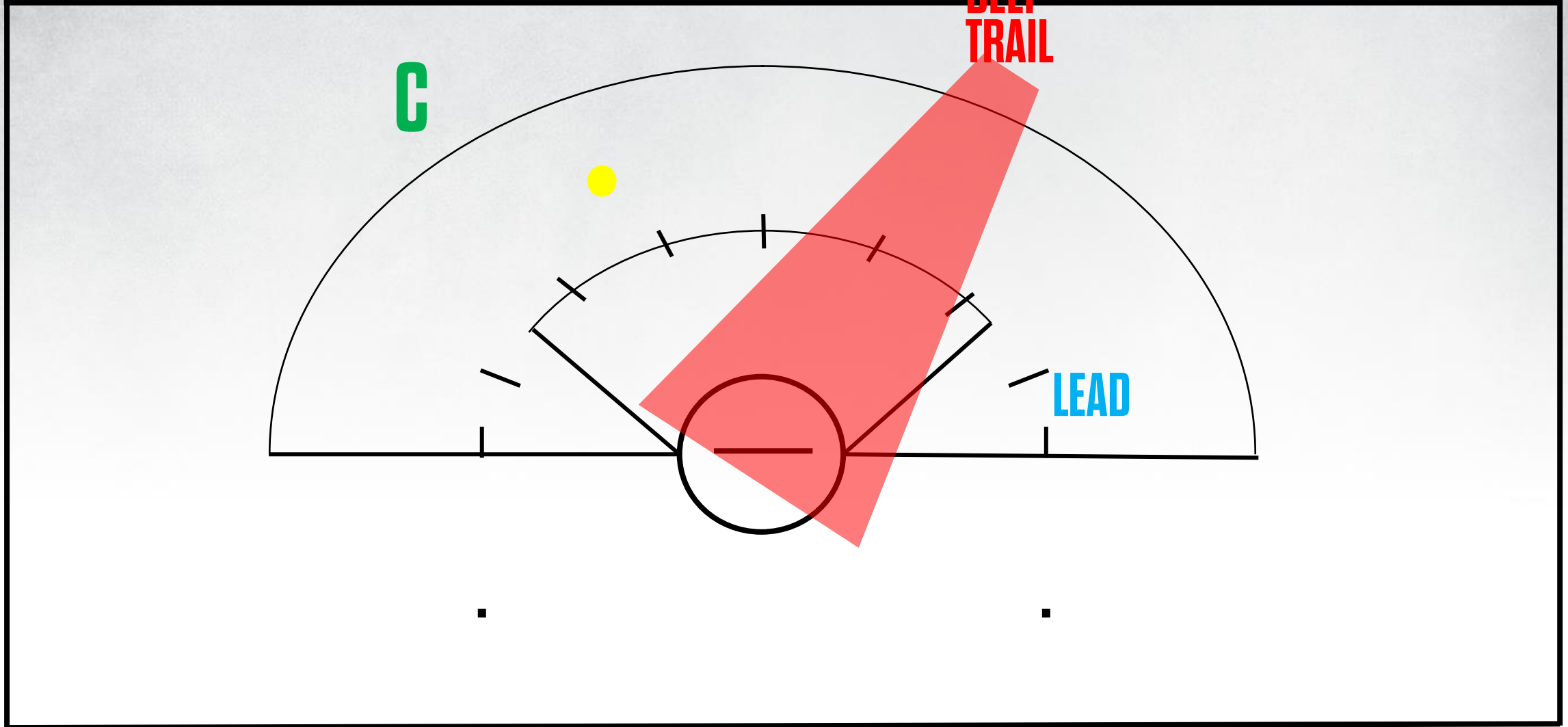



# Deep Trail Focus



C

TRAIL

LEA  
D



# Deep Trail Focus



C

TRAIL

LEAD

# Deep Trail Focus



C

LEA  
D

TRAI  
L

# Officials' Triangle

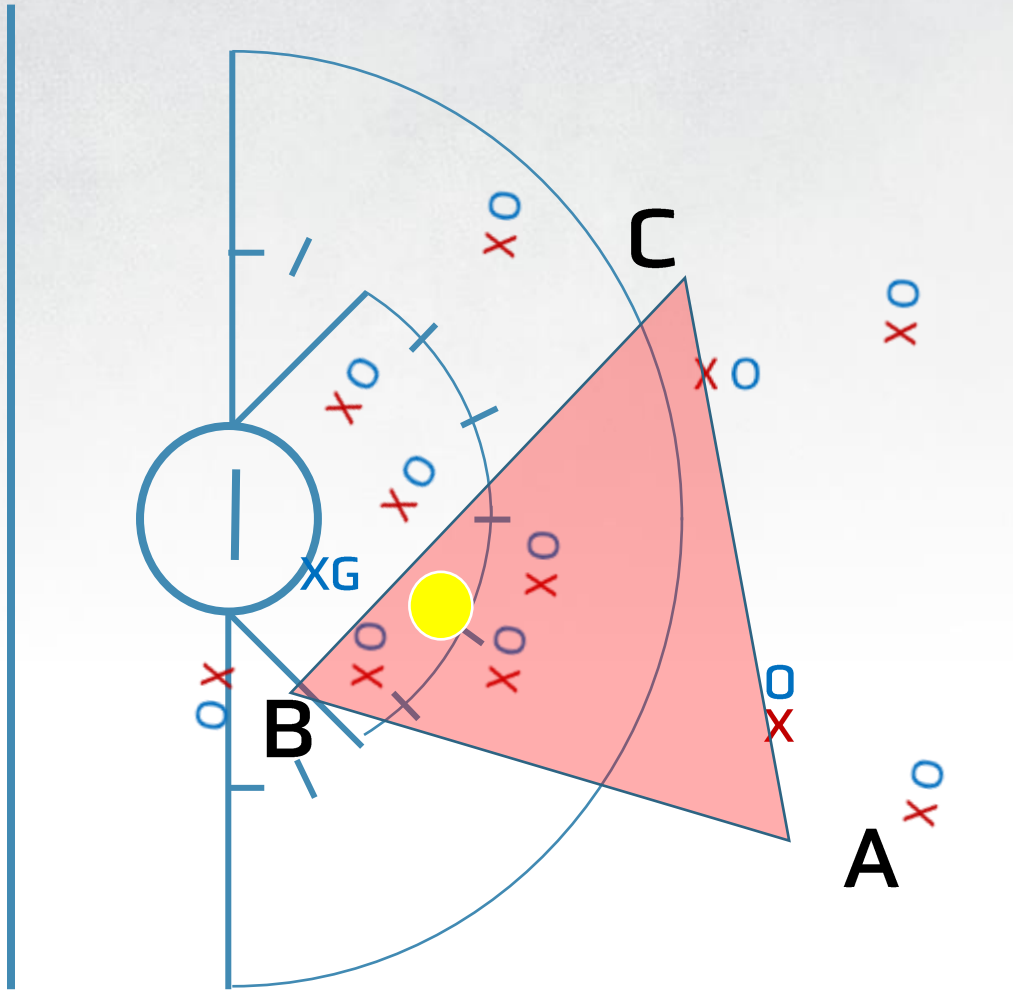

Ball stays in  
“triangle”  
between  
officials.

As ball  
moves,  
officials  
move!



# Officials' Triangle

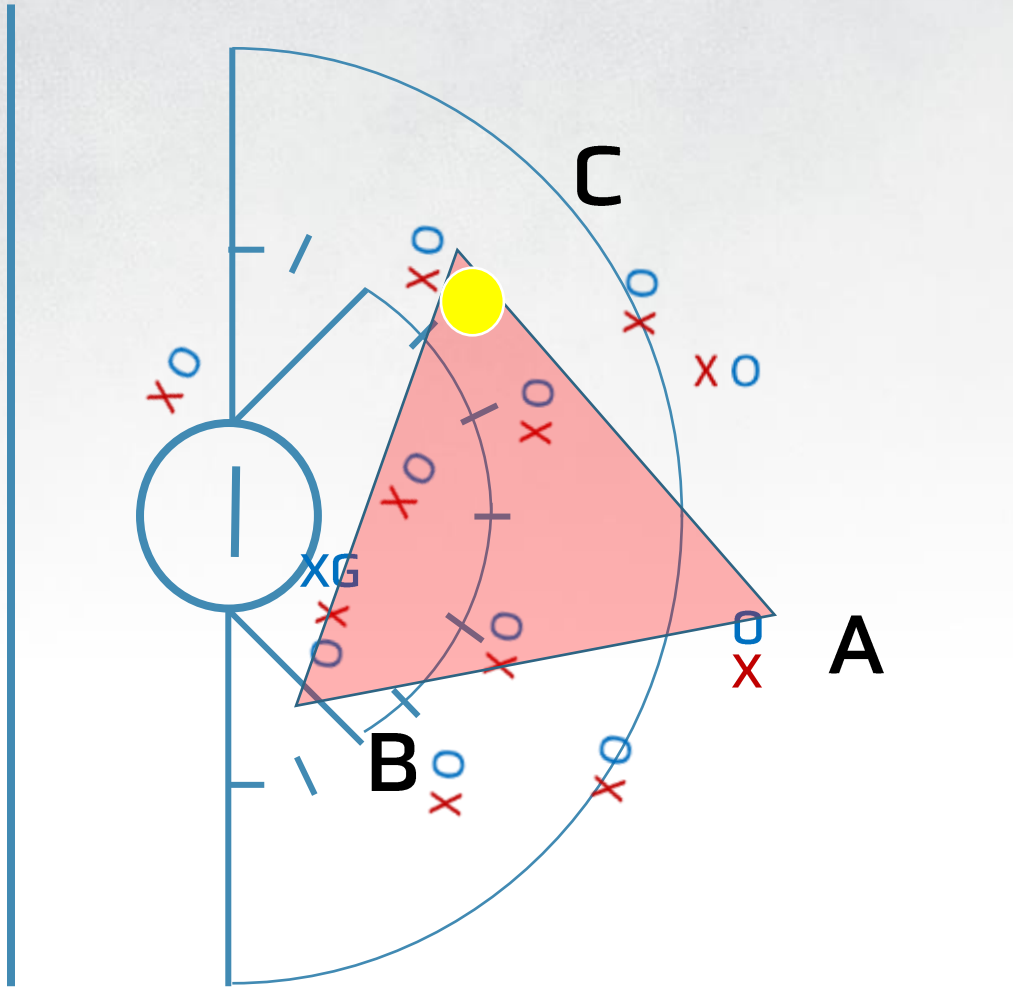

The size of the triangle changes as play progresses.



# Officials' Triangle

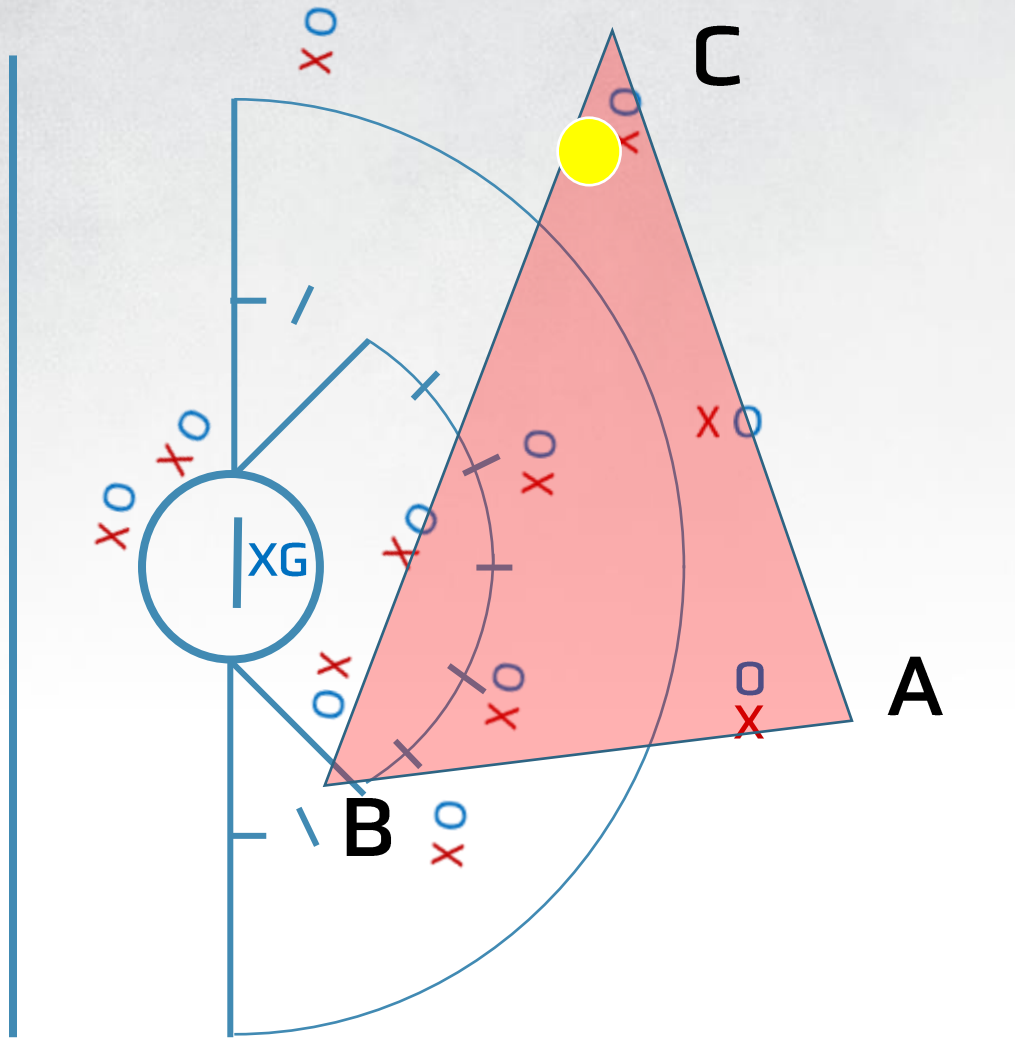

Wider play  
(ball out  
towards  
sidelines or  
out of CSA)  
creates a  
bigger  
triangle.

# Officials' Triangle

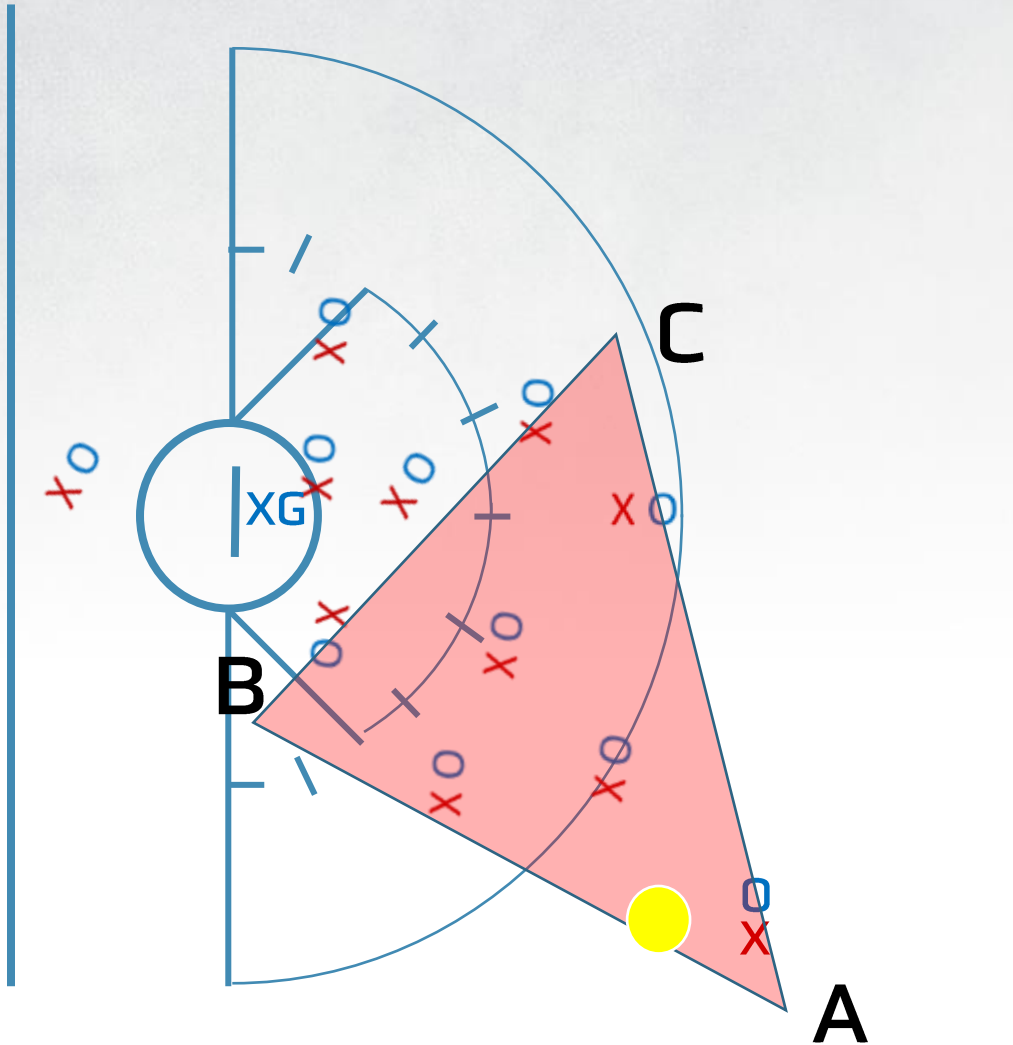

Play dictates how the triangle moves.

Officials should work to keep the ball in the triangle.

# Officials' Triangle

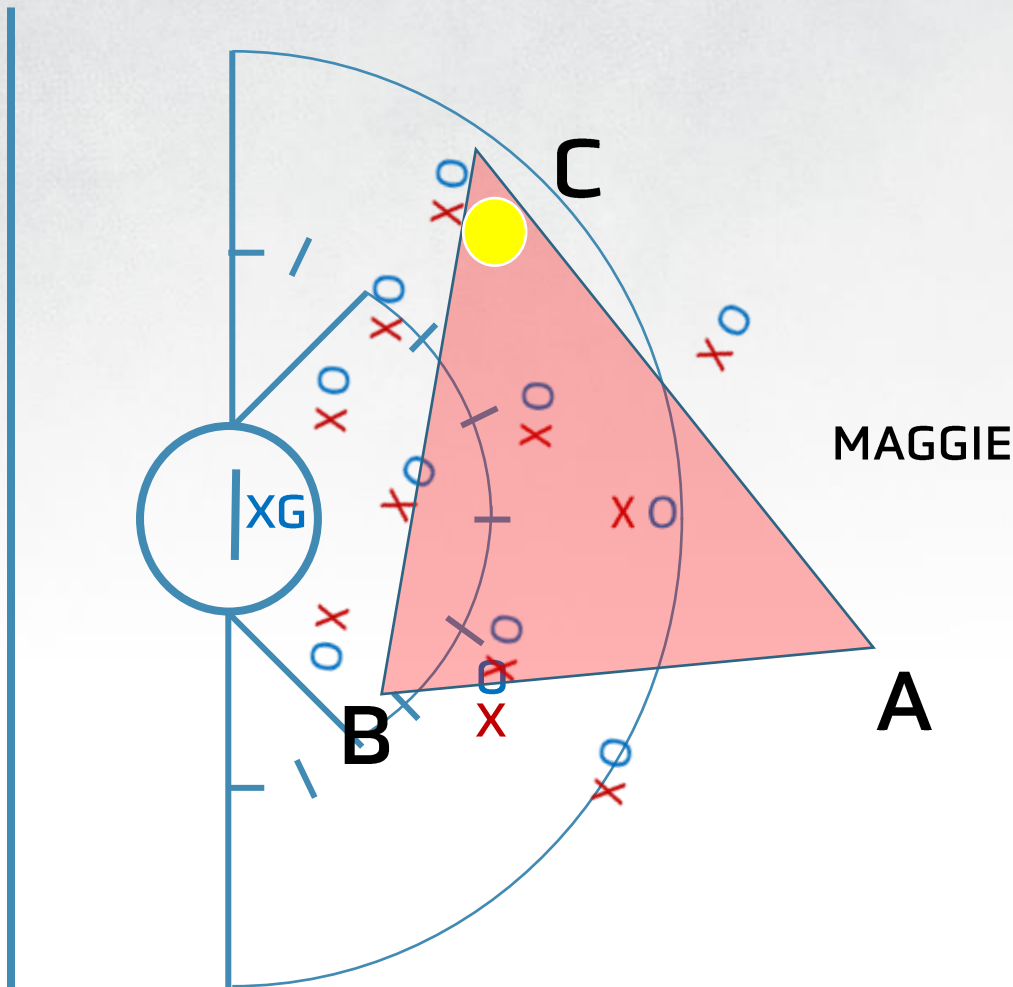

Lead Official (B) adjusts to ball.

C and Deep Trail (A) adjust relative to the ball and each other.



# WARNING

Positioning is based on changing play rather than being in particular places on the field



 does NOT mark the spot

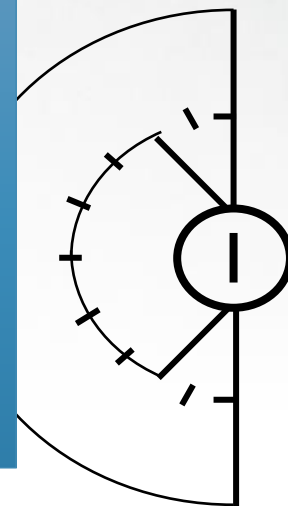



# Areas Of Coverage In The CSA

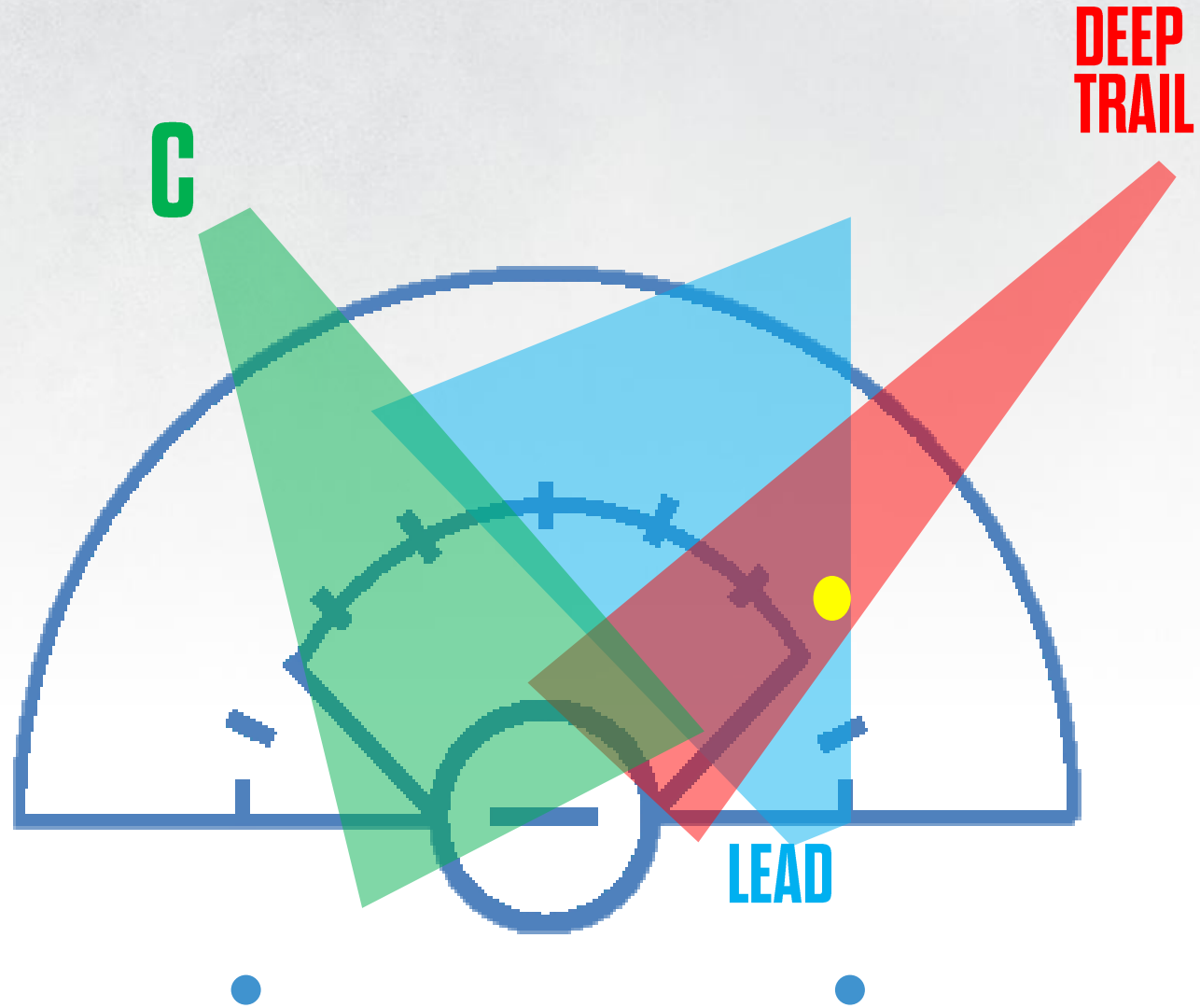

# Responsibilities

Off ball fouls  
Hold/Detain  
Illegal Picks  
Three Seconds  
Dangerous Follow Through  
Dangerous Propelling  
Fouls after the shot  
Offside

**C**

**DEEP TRAIL**

Shooting Space  
Offside  
Dangerous Follow Through  
Dangerous Propelling  
Fouls after shot  
Hold/Detain  
Illegal Picks  
Three Seconds

**LEAD**

On ball fouls  
Goal Circle  
Fouls After the shot

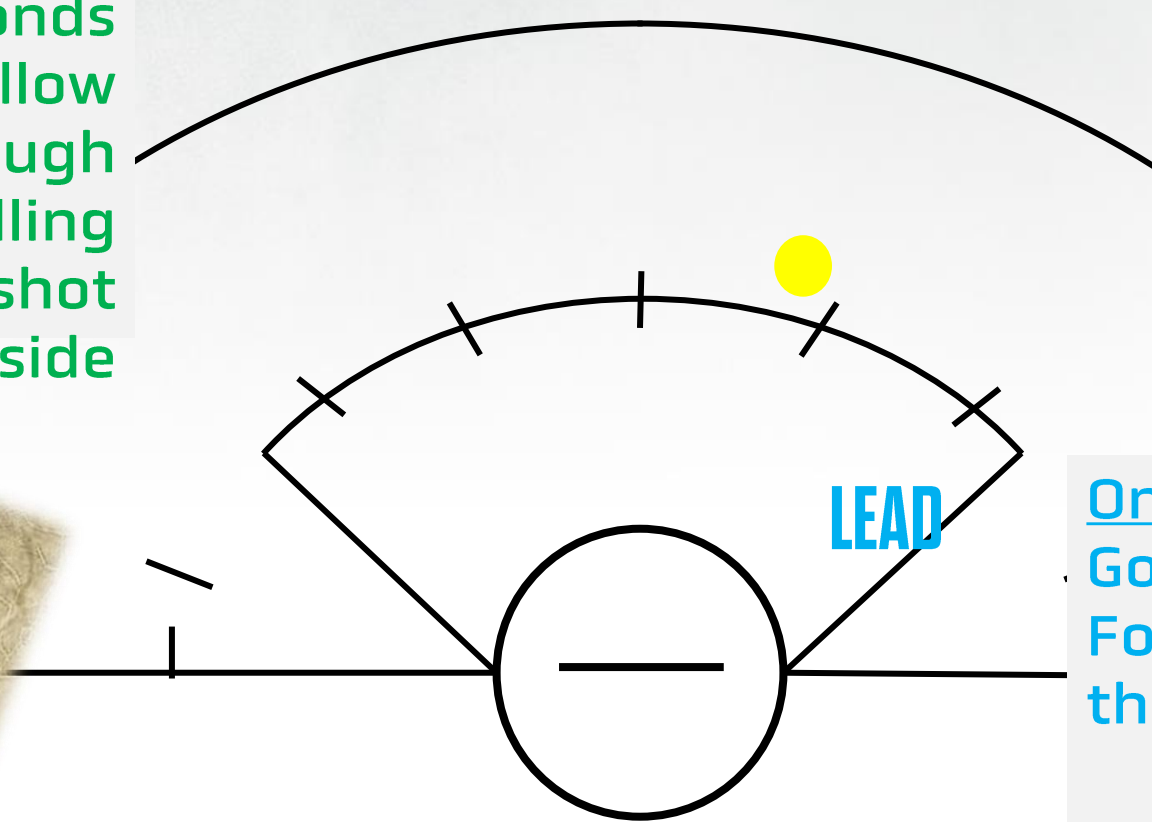
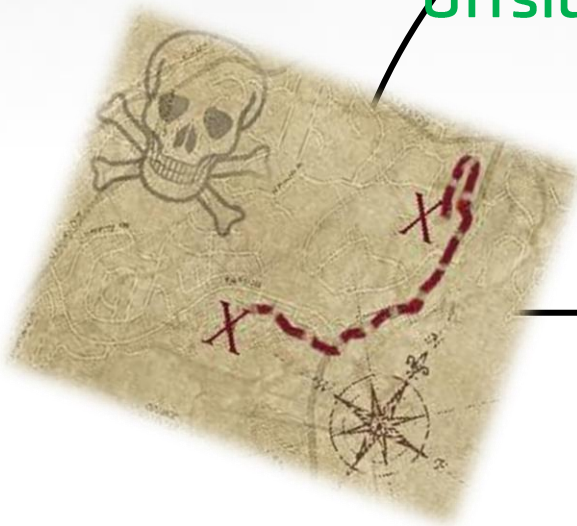

# Responsibilities And Priorities Shift



On ball fouls  
Shooting Space  
Dangerous Follow  
Through  
Dangerous Propelling  
Fouls after shot  
Hold/Detain  
Illegal Picks  
3 Seconds  
Goal Circle  
Offside



**C**

**DEEP  
TRAIL**

**LEAD**

Off ball fouls  
Offside  
Hold/Detain  
Illegal Picks  
3 Seconds  
Dangerous Follow  
Through  
Dangerous Propelling  
Fouls after shot

Hold/Detain  
3 Seconds  
Illegal Picks  
Goal/Goal Circle  
On ball fouls



# Restarts Inside The Restraining Line

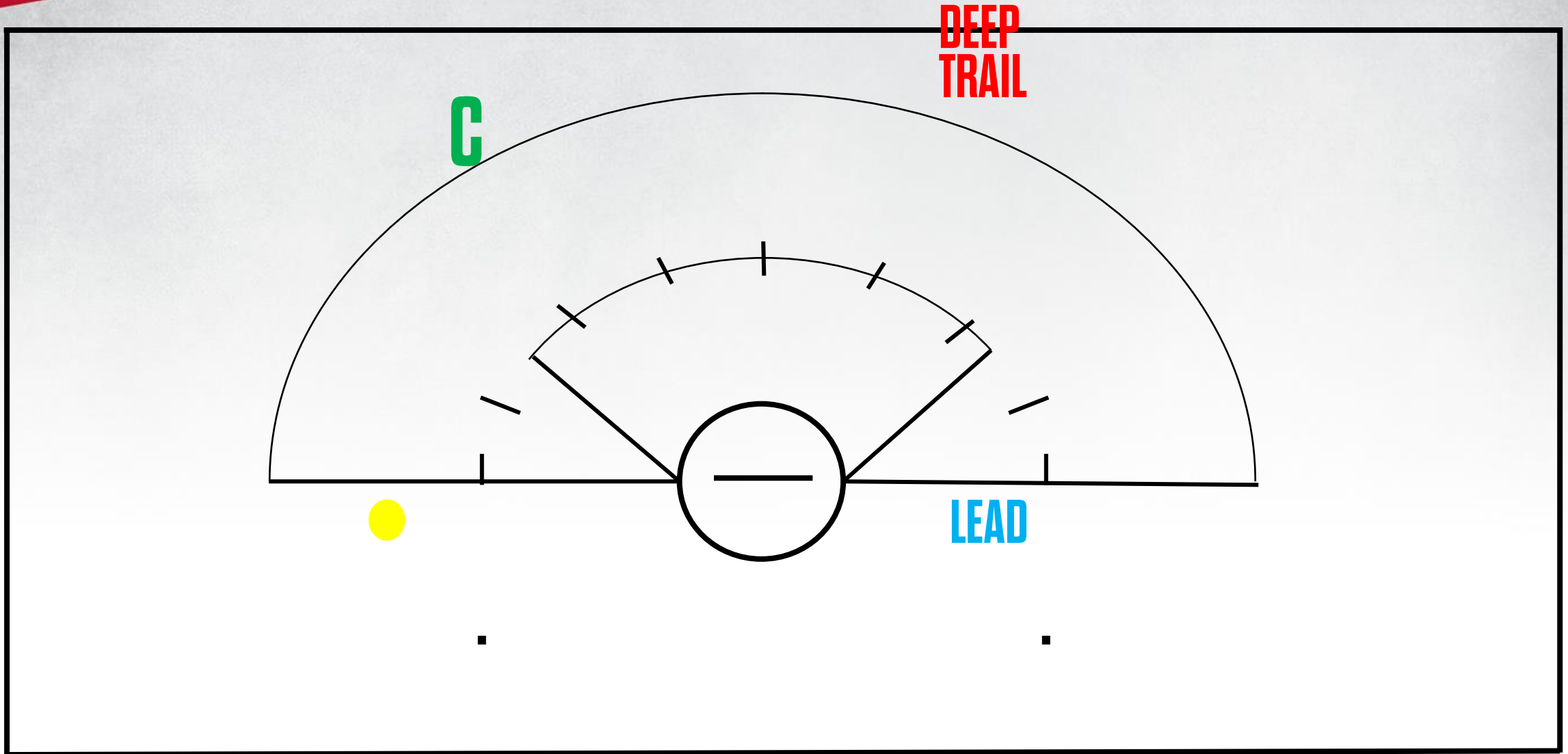

End line and most restarts below the GLE will be the LEAD



# Restarts Inside The Restraining Line

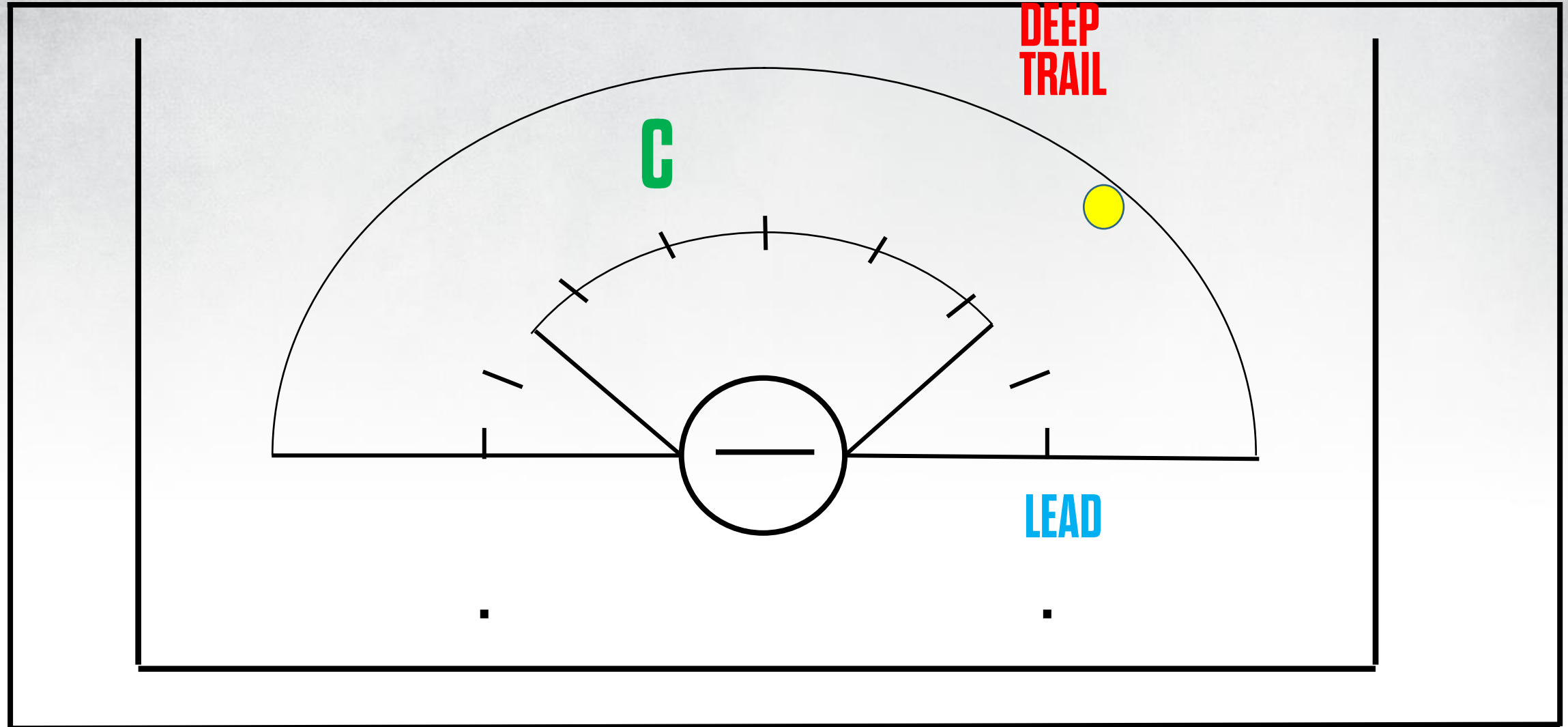

# Restarts Inside The Restraining Line

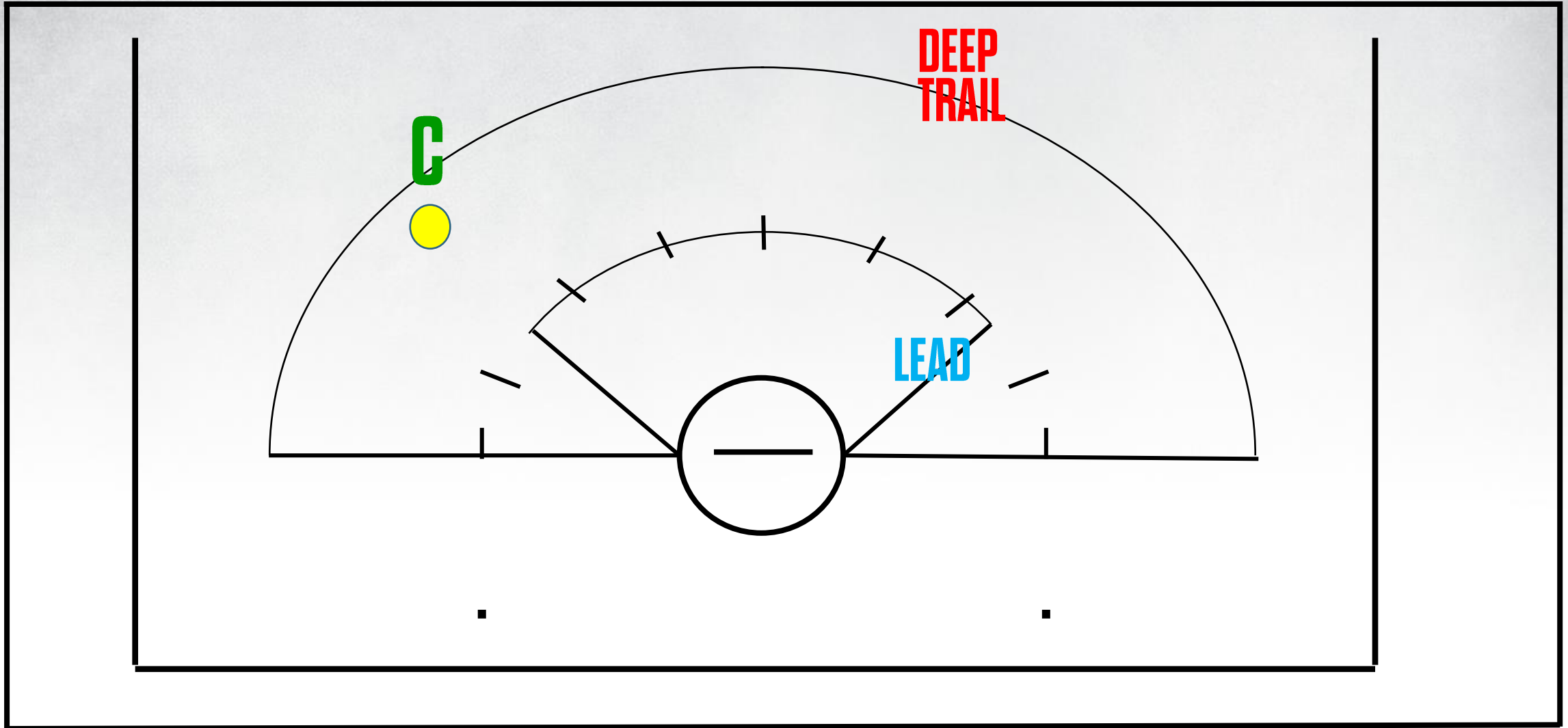

# Restarts Inside The CSA

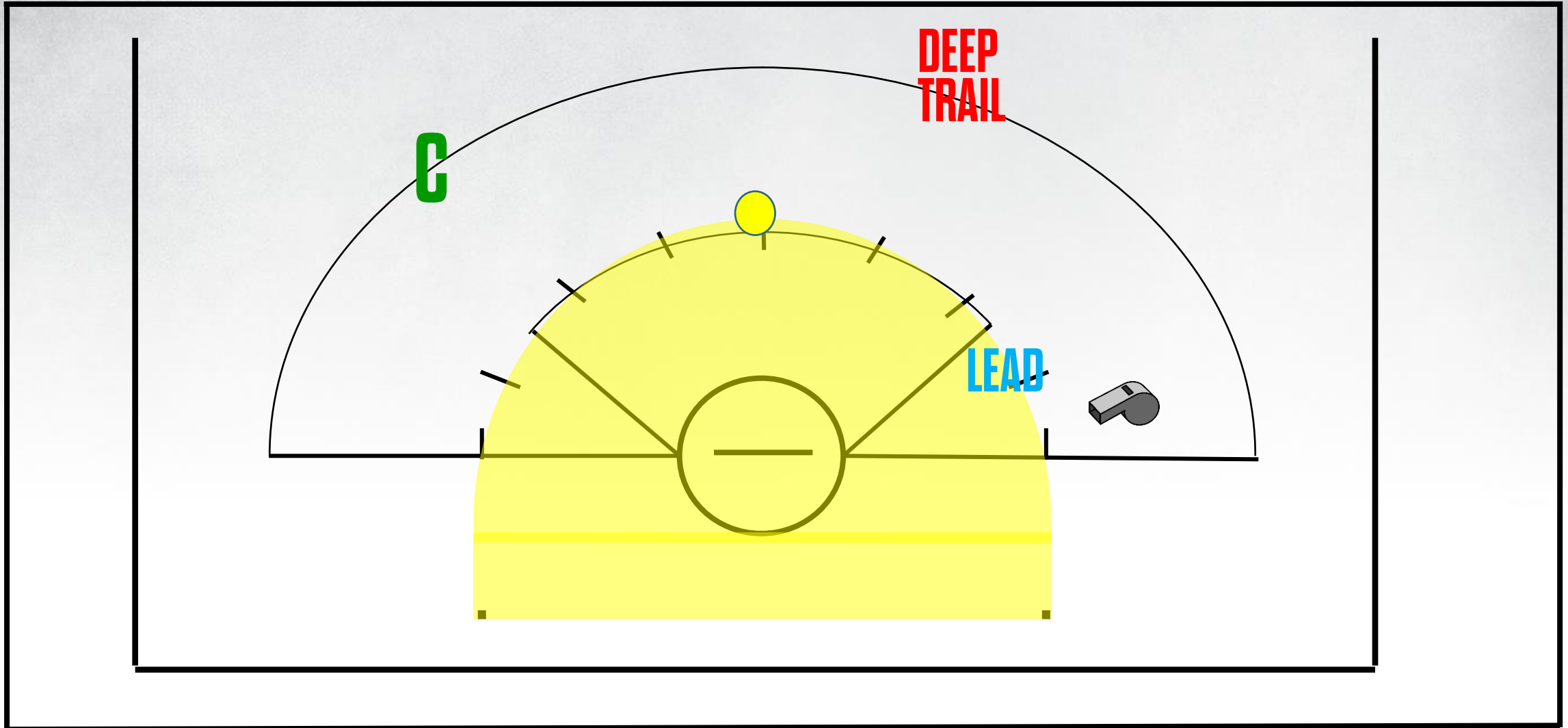

# Calls/Restarts In the Coffin Corner

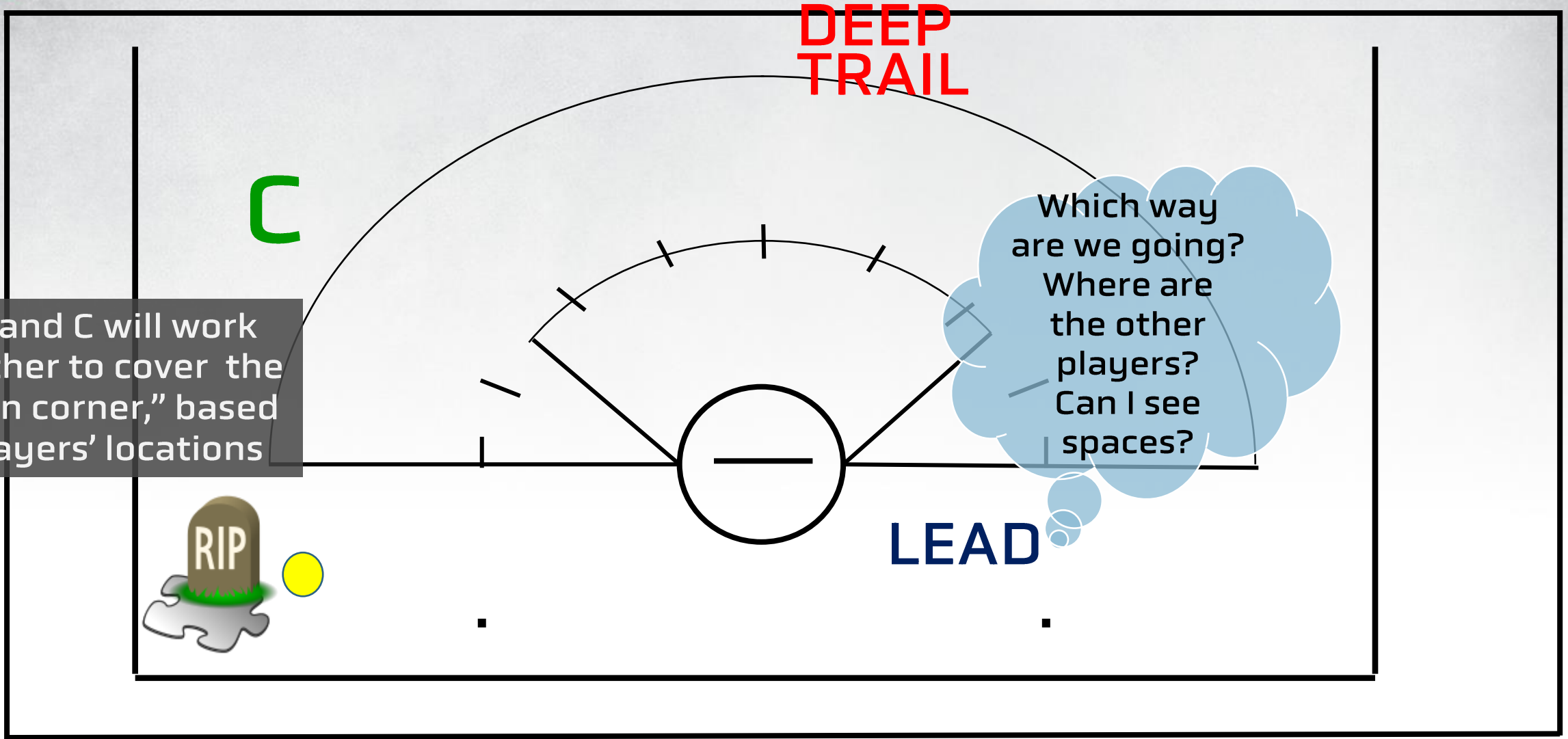

Lead and C will work together to cover the "coffin corner," based on players' locations



# Reminder: No Self-Starts in the CSA!

All officials should work to preventively manage defensive false starts heading out of the CSA

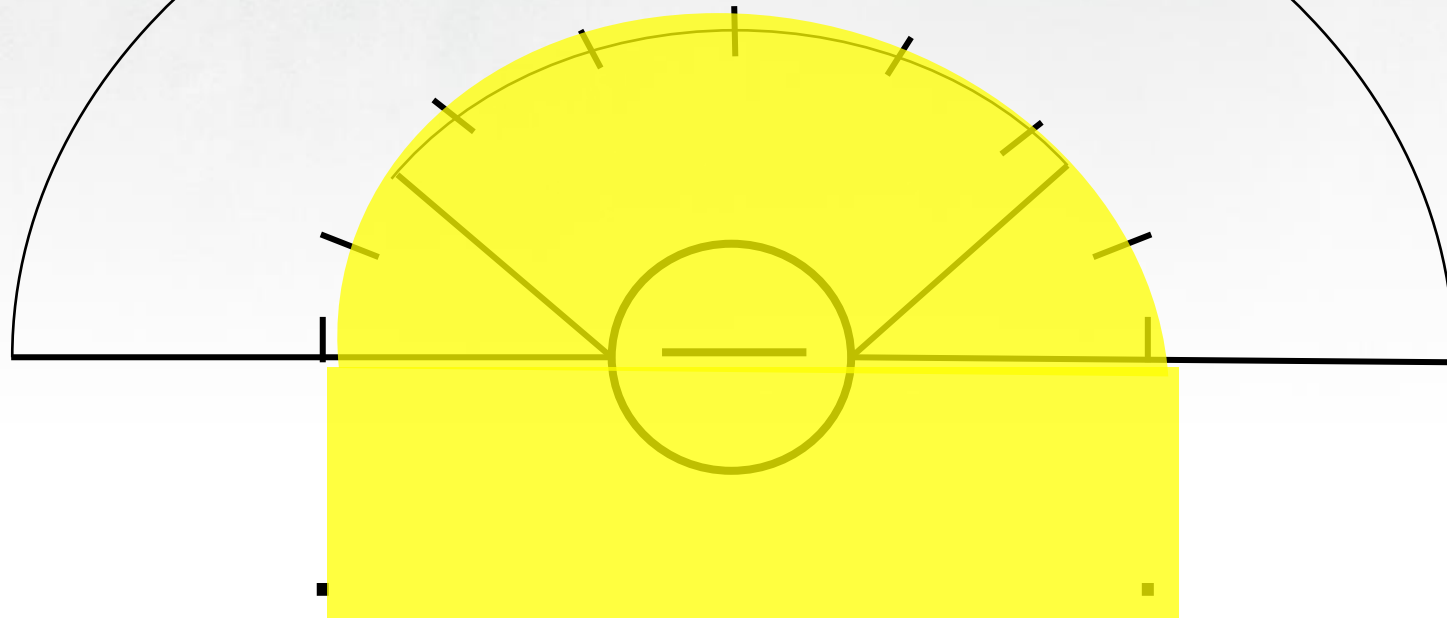

# Restraining Line Responsibilities

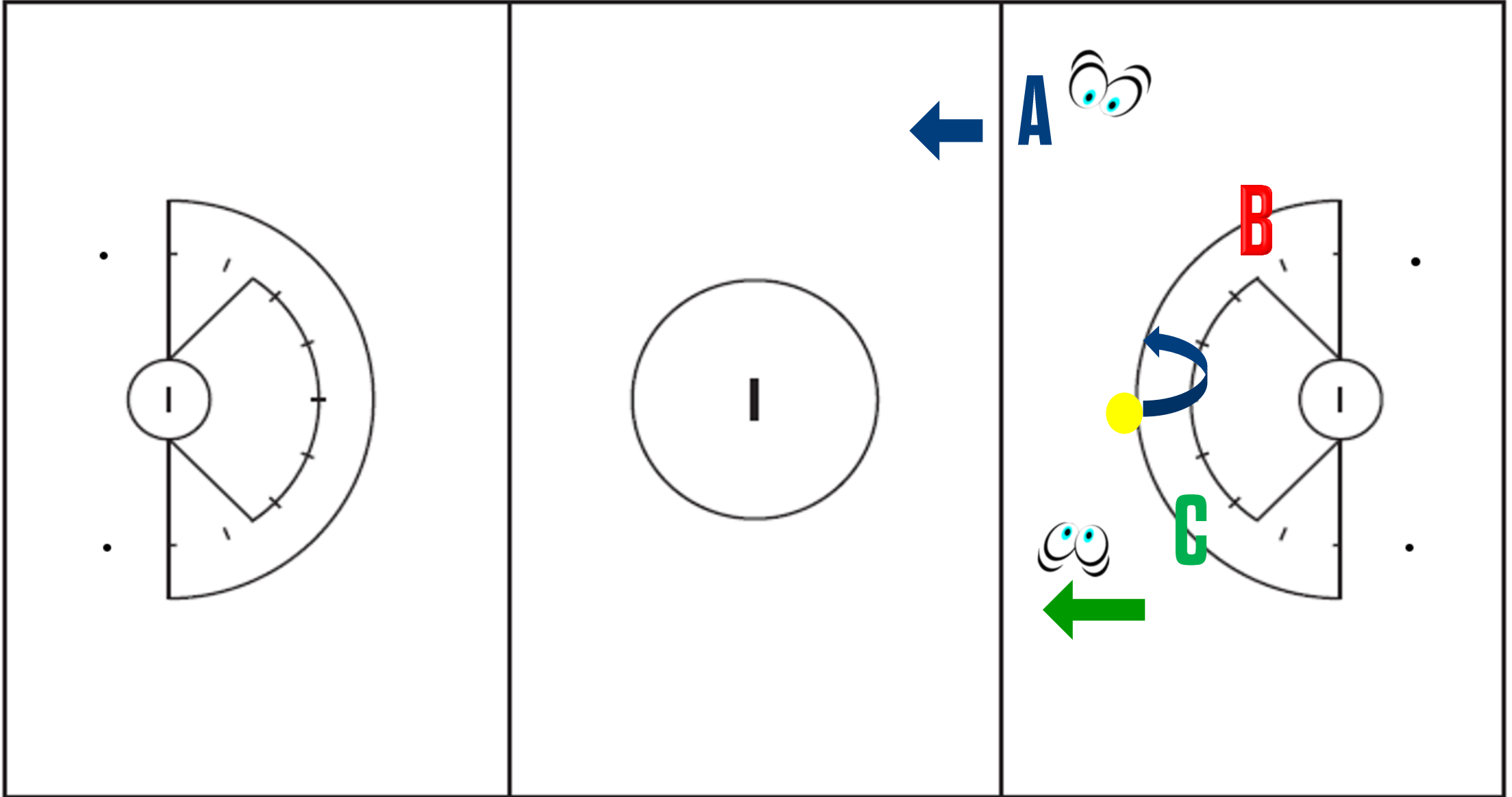

# Restraining Line Responsibilities

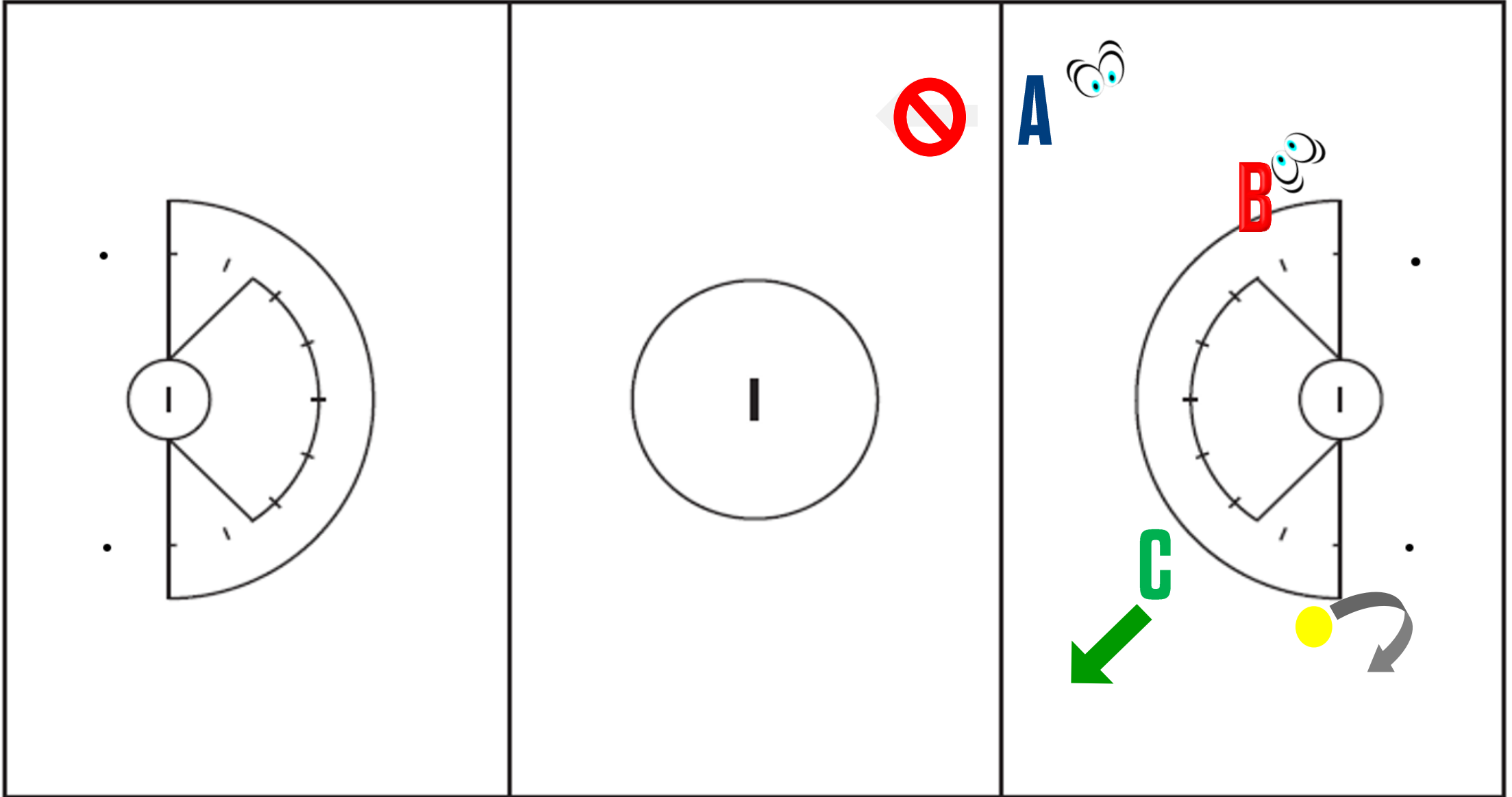

# Restraining Line Responsibilities

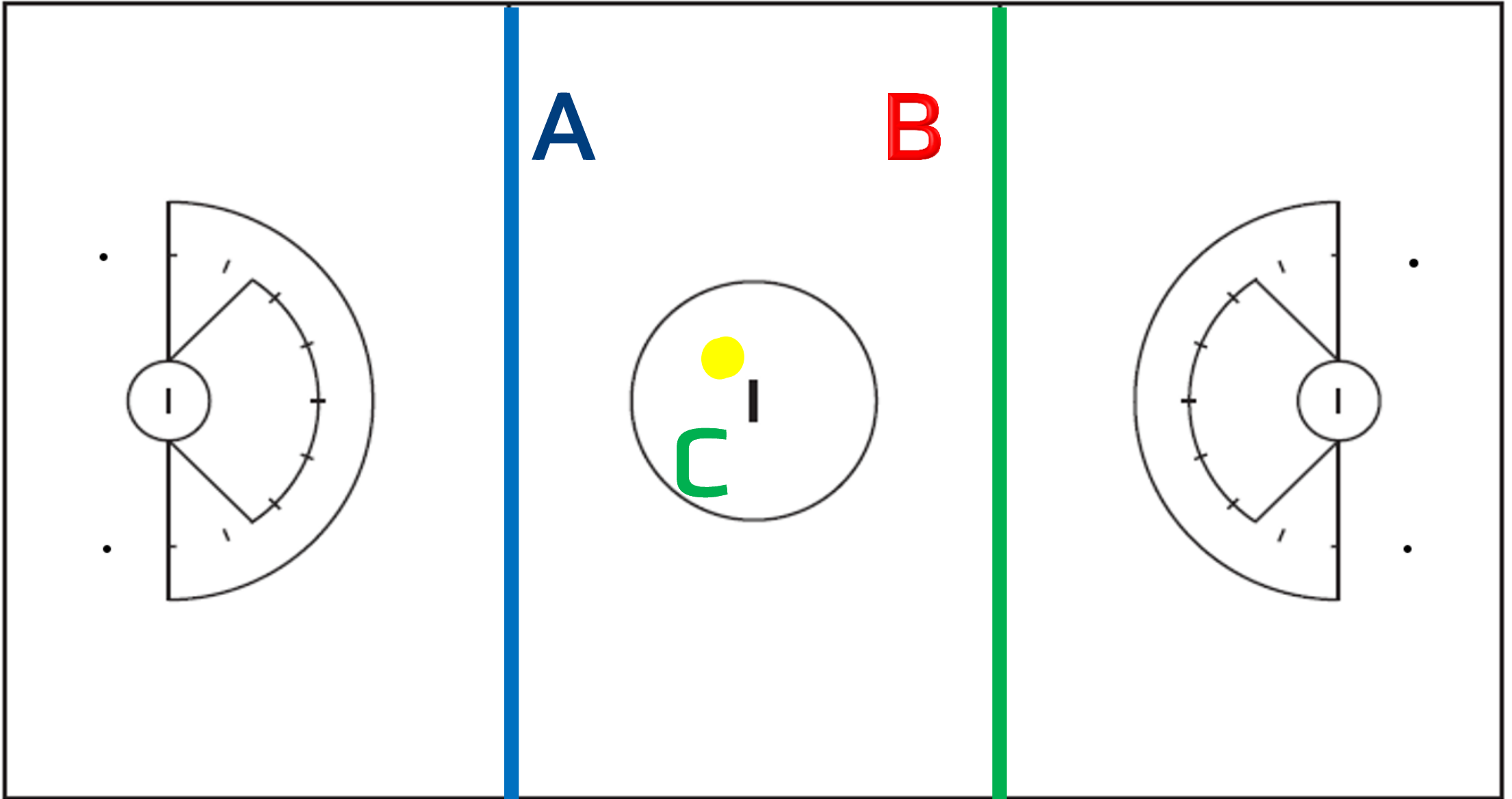



# Summary

- Ball location determines the responsibilities and positioning for each official
- In the CSA:
  - Lead is primarily on-ball
  - C serves as both second Lead and second Trail
  - Deep Trail is off-ball
- The “Triangle” is important
- Thorough pregame discussion regarding responsibilities and coverage is essential!

**THANK YOU**



[LAXCON.USLACROSSE.ORG](http://LAXCON.USLACROSSE.ORG)